

REMOTE I/O



Product	Installation in Zone						Series	Page	WebCode
	0	1	2	20	21	22			
Analog Modules									
Analog Universal Module HART for Zone 1 / Div. 1		•	•		•	•	9468/32	96	9468A
Analog Universal Module HART for Zone 2 / Div. 2			•			•	9468/33	99	9468B
Analog Universal Module HART Zone 2 / Div. 2 Ex n			•				9469/35	102	9469A
CPU & Power Modules									
CPU & Power Module for Zone 1 / Div. 1		•	•		•	•	9440/22	80	9440A
CPU Module for Zone 2 / Div. 2			•				9442/35	83	9442A
Ethernet CPU Module for Zone 1 / Div. 1		•	•		•	•	9441/12	90	9441A
Ethernet Power Module for Zone 1 / Div. 1		•	•		•	•	9444/12	93	9444A
Power Module for Zone 2 / Div. 2			•				9445/35	87	9445A
Digital Input Output Modules									
Digital Input Output Module 24 V for Zone 2 / Div. 2 Ex n			•				9472/35	114	9472A
Digital Input Output Module for Zone 1 / Div. 1		•	•		•	•	9470/32	105	9470C
Digital Input Output Module for Zone 2 / Div. 2			•		•	•	9470/33	108	9470D
Digital Input Output Module NAMUR for Zone 2 / Div. 2 Ex n			•				9471/35	111	9471B
Digital Output Modules									
Digital Output Module 8-Channel Version for Zone 1 / Div. 1		•	•		•	•	9475/32-08	117	9475C
Digital Output Module 8-Channel Version for Zone 2 / Div. 2			•			•	9475/33-08	120	9475D
Digital Output Module Valve for Zone 1 / Div. 1		•	•		•	•	9478	123	9478A
Enclosures for Fieldstations									
Standard Enclosure Zone 1 for Remote I/O		•	•				8150	132	8150D
General									
General								79	
Overview of Functions IS1+								78	
Overview of the System Components								78	
System Components and Accessories									
BusRail		•	•		•	•	9494	130	9494A

Product	Installation in Zone						Series	Page	WebCode
	0	1	2	20	21	22			
Temperature Input Modules									
Temperature Input Module for Zone 1 / Div. 1		•	•		•	•	9482/32	125	9482A
Temperature Input Module for Zone 2 / Div. 2			•			•	9482/33	127	9482B

For additional products and information please refer to r-stahl.com

Overview of the System Components

A4

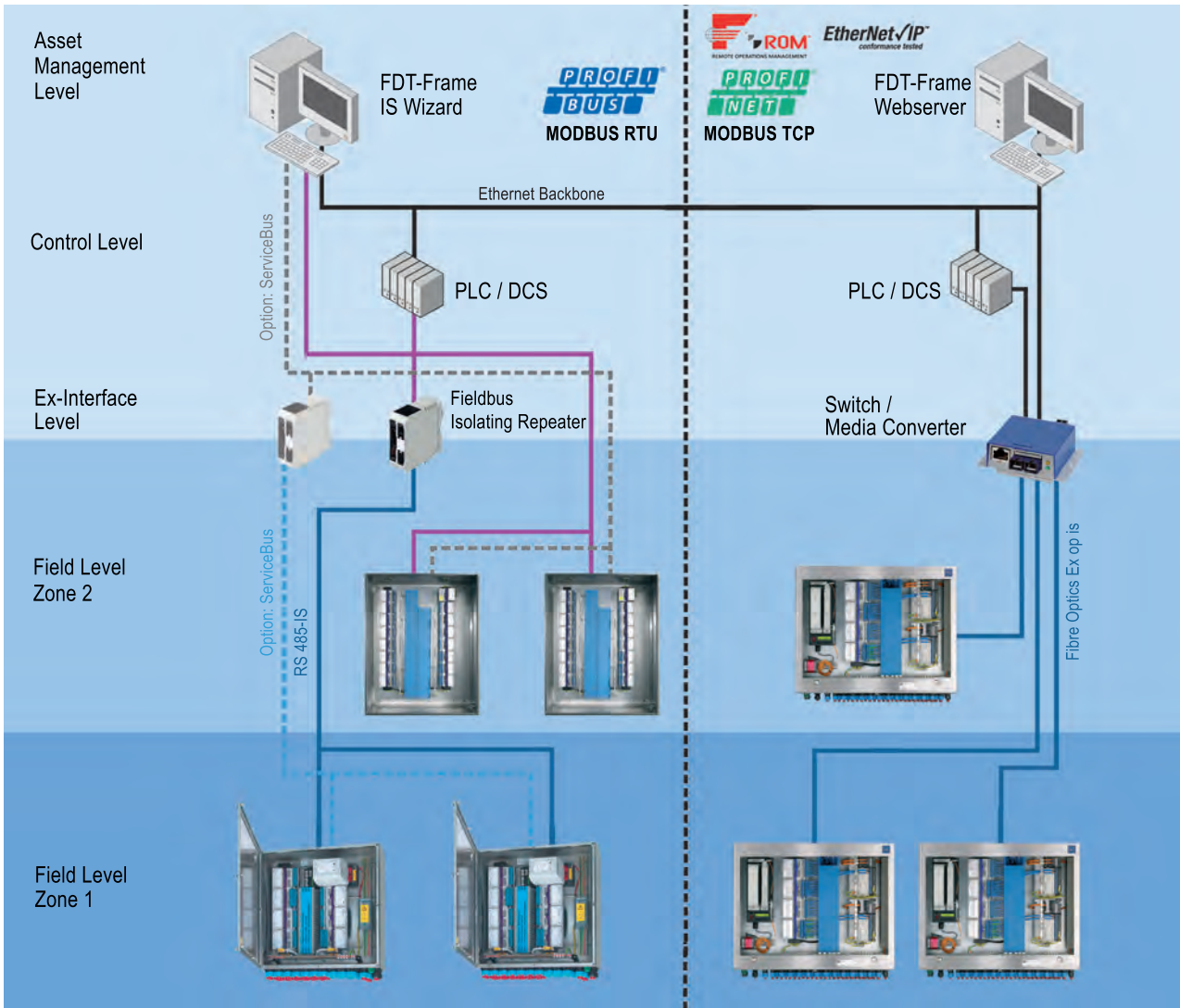

Overview of Functions IS1+

	Installation in Zone 2	Installation in Zone 1	RS485-IS	100BASE-TX	LWL ex op is	ServiceBus IS Wizard	ServiceBus DTM	Webserver	COM/Device/ Gateway DTM	HART support	System redundancy
PROFIBUS DP	x	x	x ¹⁾		x	x	x		x	x	x
Modbus RTU	x	x	x ¹⁾		x	x	x		x	x	x
PROFINET	x	x		x	x	x		x		x	x ²⁾
Modbus TCP	x	x		x	x	x		x	x	x	x
EtherNet/IP™	x	x		x	x	x		x	x	x	x ²⁾

¹⁾ when installed in Zone 1 only; in Zone 2: RS485

²⁾ in preparation

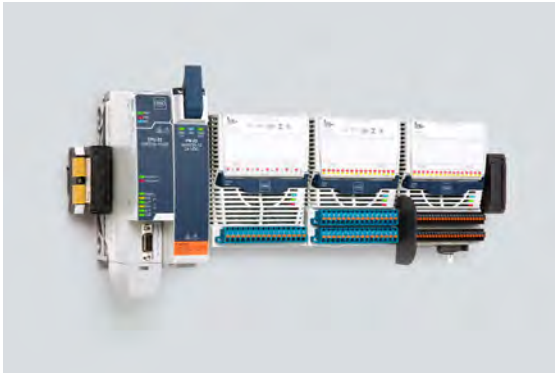

- Inputs and outputs for intrinsically safe (Ex i) and non-intrinsically safe (Ex e/d/q) field devices
- Communication via PROFIBUS DP, Modbus RTU+TCP, PROFINET and EtherNet/IP™
- Hot swap for all modules in Zone and Zone 2
- System redundancy and media redundancy
- Option ServiceBus for diagnostics and integration into Asset-Management systems
- DTM technology for full access to all system and HART field device information
- Field enclosures in many versions available, freely configurable

A4



IS1+ is exceptionally easy: communication and power modules are installed on a DIN rail together with the different input/output modules. The system's internal, intrinsically safe power supply and data communication is via the bus rail, which is snapped into the DIN rail. The unique power supply concept which was developed specially for hazardous areas makes planning as easy as for normal industrial I/O systems. Plug & Play without separate engineering tools.

IS1 is particularly flexible: it can be used for small and large signal volumes, intrinsically safe and non-safe signals and installation in hazardous areas of Zone 1 and 2 or Division 1 and 2. Intrinsically safe fieldbuses with copper or fibre optic technology and 100 Mbps Ethernet and various redundancy structures combine the field stations with all conventional automation systems. Modern standard technologies such as completely transparent HART transmission and FDT/DTM are supported throughout.

IS1+ is extremely cost-efficient: modules with up to 16 channels, partly free for parameterization as input or output, ensure a low signal price. Special modules optimised for Zone 2 / Div. 2 installation allow for additional cost reduction. High performance interfaces, e.g. with DTM support, and the integrated diagnostic functions according to NAMUR NE107, allow easy integration of the system into asset management and engineering systems and thus help to significantly reduce costs for operation, troubleshooting and maintenance.

IS1+ is truly universal: the application options are versatile, IS1 can be used effectively in virtually all applications. No matter whether for installation according to ATEX, IECEx, NEC or elsewhere in the world, on land, offshore platforms or in shipbuilding - IS1 offers the broadest spectrum of certificates and approvals. A temperature range of -40 to +75 °C is ideal for the most extreme requirements. Add to this, our competence in system solutions with over 30 years of experience for making your bespoke solution from universal remote I/O.



- Suitable for Ex i V0/V1 HART PROFIBUS DP, Modbus RTU
- Supporting system redundancy and optical rings
- CPM in Zone 1 can be hot swapped
- Integration in plant asset management systems via ServiceBus and FDT/DTM
- Integrated Ex i power supply for up to 8 I/O modules

A4

WebCode **9440A**



Modbus RTU



9440/22 series CPU & power modules (CPM) for Zone 1 are used for the intrinsically safe supply of power to up to eight IS1+ I/O modules and to field circuits. Intrinsically safe RS485-IS with PROFIBUS DP or Modbus RTU is used for communicating with the automation system. These CPMs support system and optical rings and can be replaced while the system is in operation (i.e. hot swapped) in Zone 1/Division 1. A DTM and process bus or service bus are used for asset management integration.





	ATEX / IECEx						NEC 505						NEC 506						NEC 500					
	0		1		2		20		21		22		Class I		Class II		Class III		Class I		Class II		Class III	
Zone	•	•	•	•	•	•	•	•	•	•	•	•	•	•	•	•	•	•	•	•	•	•	•	•
Ex interface			•	•					•	•					•	•					•	•		
Installation in			•	•					•	•					•	•					•	•		

Selection Table							
Zone 1 / Division 1							
Installation	Nominal voltage	Protocols	Redundancy	Product Type	Art. No.	PS	Weight kg
24 V DC	Profibus DP V0 Profibus DP V1 Profibus DP V1 HART	full redundancy	9440/22-01-11-C1243	162218 ▲	22	2.963	
120 V / 230 V AC	Profibus DP V0 Profibus DP V1 Profibus DP V1 HART	full redundancy	9440/22-01-21-C1243	162211 ▲	22	2.963	





Please order the 9490 socket (see accessories) separately.

Technical Data		
Variant	24 V DC	120 V / 230 V AC
Explosion Protection		
IECEx gas explosion protection	Ex d [ia] [ib] IIC T4 Gb	Ex d [ia] [ib] IIC T4 Gb
ATEX gas explosion protection	⊕ II 2 G Ex d [ia] [ib] IIC T4 Gb	⊕ II 2 G Ex d [ia] [ib] IIC T4 Gb
EAC gas explosion protection	⊕ 1 Ex d [ia Ga] [ib] IIC T4 Gb X	⊕ 1 Ex d [ia Ga] [ib] IIC T4 Gb X
Certificates	ATEX (DEK), Brazil (ULB), Canada (CSA), Canada (FM), EAC (STV), IECEx (DEK), Korea (KTL), USA (FM)	ATEX (DEK), Brazil (ULB), Canada (CSA), Canada (FM), EAC (STV), IECEx (DEK), Korea (KTL), USA (FM)
Ship approval	ABS, CCS, ClassNK, DNVGL, RINA	ABS, CCS, ClassNK, DNVGL, RINA

Technical Data		
Variant	24 V DC	120 V / 230 V AC
Electrical Data		
Transmission distance/rate for copper RS485	1200 m at 9.6...93,75 kbit/s 1000 m at 187.5 kbit/s 400 m at 500 kbit/s 200 m at 1.5 Mbit/s	1200 m at 9.6...93,75 kbit/s 1000 m at 187.5 kbit/s 400 m at 500 kbit/s 200 m at 1.5 Mbit/s
Connection Fieldbus RS485	Sub-D socket 9-pole	Sub-D socket 9-pole
Connection ServiceBus RS485	Sub-D socket 9-pole	Sub-D socket 9-pole
Auxiliary Power		
Auxiliary power voltage range	20 ... 35 V DC	90 ... 253 V AC
Current consumption (without I/O modules)	0.21 A at 24 V DC	Approx. 25 mA at 230 V AC Approx. 48 mA at 120 V AC
Current consumption (with 8 I/O modules)	Approx. 2.5 A at 24 V DC	Approx. 0.4 A at 230 V AC Approx. 0.8 A at 120 V AC
Power dissipation (without I/O modules)	5 W	8.4 W
Power dissipation (per I/O module)	1.4 W	1 W
Ambient Conditions		
Ambient temperature	-20°C ... +65°C	-20°C ... +65°C
Mechanical Data		
Degree of protection IP (IEC 60529)	IP20 connections IP30 modules	IP20 connections IP30 modules
Width	96.5 mm	96.5 mm
Depth	170 mm	170 mm
Length	253 mm	253 mm

Accessories				
Figure	Description	Art. No.	PS	Weight kg
Cable for PROFIBUS DP, RS 485, RS485-IS				
	Cable type: BUS 4000-C-PE 2x0,64mm 02YS(St) CY2Y Colour (sheath): black Application area: Outdoor Installation outdoors and directly in the ground, UV-resistant	105444	Z2	0.300
Cable for PROFIBUS DP, RS485-IS				
	Cable type: 02YS(St) CHSH Colour (sheath): blue Application area: Offshore Halogen-free, steel wire braid armoured cable	105400	Z2	0.001
	Cable type: BUS 4000-C-PVC 2x0,64mm 02YS(St) CY Colour (sheath): blue Application area: Indoor Standard type for indoor installation	105437	Z2	0.001
Socket for CPU and Power Module Series 9490				
	Zone 1 connection by means of Ex e terminals 24 V DC, 120 / 230 V AC	162707 ▲	Z2	0.482
	Zone 1, connection via pig tail 24 V DC, 120 / 230 V AC	162711	Z2	0.900
	Division 1, connection via conduit 24 V DC, 120 / 230 V AC	162715	Z2	0.900
SUB-D socket				
	9-pin for connection of the fieldbus or ServiceBus to the CPU & power module Series 9440/22 and fieldbus-isolating repeater 9185. Integrated terminator can be switched on or off. For RS 485 IS to PNOstandard.	162693 ▲	Z2	0.100

Accessories

Figure	Description	Art. No.	PS	Weight kg
Optical Fieldbus Isolating Repeater, Zone 2 / Div. 2				
	Isolating repeater for installation in Zone 2 / Div. 2 For fieldbus via fibre optic intrinsically safe cables "ex op is" into Zone 1 / Div. 1 Optical ring possible Extensive diagnostic function and fault-contact Suitable for Profibus DP up to 1.5 MBit/s Further versions and information see data sheet of Series 9186 optical fieldbus-isolating repeater	160624 ▲	25	0.244
Fieldbus Isolating Repeater Series 9185/11				
	Equipment for installation in safe areas or Zone 2/Div. 2 For fieldbuses with RS-485-IS-interface - Zone 1 / Class I, II, III Division 1 and Class I, II, III Zone 1 Suitable for PROFIBUS DP, Modbus, R. STAHL service bus RS-232, RS-422, RS-485 interface with the automation system Transmission rate automatically set with PROFIBUS DP Adjustable transmission rate (1.2 kBit/s to 1.5 MBit/s) 24 V AC/DC auxiliary power For further information, see data sheet for 9185/11	227598 ▲	21	0.350
Device DTM IS1+ for PROFIBUS DP and Ethernet				
	Parameterization and configuration of the IS1+ system Communicating with HART-compatible field devices Supports all common FDT frame applications (e.g. FieldCare, PactWare™) Condition Monitoring Scan function for automatic topology generation Download at r-stahl.com	-	-	-
IS1 PCS7 APL field device library				
	Easy connection of IS1+ modules to the SIEMENS control system PCS7 via PROFIBUS DP. The library contains CFC driver modules created in conformance with PCS7 modules, and documentation in English. HOTLINE support inclusive. Order, processing and support are carried out directly via SIEMENS: function.blocks.industry@siemens.com Hardware/software requirements: SIEMENS PCS7 V7.1 to 8 SP2 and IS1+ CPM 9440/...C1455 from V03.45 and GSD from V03.05	-	-	-

Dimensional drawings on the Internet r-stahl.com

A4



- Support for PROFIBUS DP, PROFINET, Modbus RTU, Modbus TCP and EtherNet/IP™; incl. HART transmission
- RS485 interfaces (max. 12 Mbit/s) and Ethernet (max. 100 Mbit/s)
- Comprehensive diagnostics based on NE 107
- Support of FDT/DTM and web server for integration in asset management systems
- Enhanced ambient temperature range from -40 °C to +75 °C

A4

WebCode **9442A**



Modbus TCP

EtherNet/IP



The 9442/35 CPU module functions as a gateway between the IS1+ Remote I/O system and the automation system. All supported communication protocols are in the CPU module and can be configured by the user. In addition to the process values, other information such as diagnostics, parameterisation and configuration is transmitted over the CPU module. Communication with the I/O modules is implemented via the 9496 socket and the 9494 BusRail. Integration in control systems and plant asset management tools is implemented using standards such as GSD, EDS, web servers and FDT/DTM.

	ATEX / IECEx					
Zone	0	1	2	20	21	22
Ex interface			•			
Installation in			•			

	NEC 505 Class I			NEC 506		
Zone	0	1	2	20	21	22
Ex interface			•			
Installation in			•			

	NEC 500					
Division	Class I		Class II		Class III	
Division	1	2	1	2	1	2
Ex interface		•		•		•
Installation in		•				

Selection Table						
Installation	Zone 2					
Protocol RS-485 Interface	Protocols RJ45	Protocols USB	Product Type	Art. No.	PS	
Profibus DP V0 Profibus DP V1 HART	MODBUS TCP EtherNet/IP PROFINET	Service Bus	9442/35-10-00	246854 ▲	22	

Please order the 9445/35 power module and 9496/35 base (see accessories) separately.

Technical Data	
Explosion Protection	
IECEx gas explosion protection	Ex ec ia [ia Ga] IIC T4 Gc
ATEX gas explosion protection	Ⓔ II 3 (1) G Ex ec ia [ia Ga] IIC T4 Gc
EAC gas explosion protection	Ex 2 Ex e ia [ia Ga] IIC T4 Gc X Ex 2 Ex nA ia [ia Ga] IIC T4 Gc X
Certificates	ATEX (PTB), Canada (FM), EAC (Sertium), IECEx (PTB), USA (FM)
Electrical Data	
Connection RS485 Interface	Sub-D plug, 9-pole
Interface RS485	acc. to Profibus specification
Protocol RS-485 Interface	Profibus DP V0 Profibus DP V1 HART
Connection Ethernet Interface	2x RJ45 connector
Interface RJ45	100BASE-TX unmanaged switch function

Technical Data

Electrical Data

Protocols RJ45	MODBUS TCP EtherNet/IP PROFINET
----------------	---------------------------------------

USB interface	Type A socket
---------------	---------------

Version USB	USB 2.0
-------------	---------

Protocols USB	Service Bus
---------------	-------------

Auxiliary Power

Power supply	via socket 9496 a. PM 9445/35
--------------	-------------------------------

Current consumption max.	0.3 A
--------------------------	-------

Power dissipation max.	5 W
------------------------	-----

Ambient Conditions

Ambient temperature	-40°C ... +65°C (without mounting plate) -40°C ... +70°C with 3 mm mounting plate sheet steel -40°C ... +75°C (with 6 mm mounting plate aluminium)
---------------------	--

Storage temperature	-40°C ... +80°C
---------------------	-----------------

Mechanical Data

Degree of protection IP (IEC 60529)	IP30
-------------------------------------	------

Accessories

Figure	Description	Art. No.	PS	Weight kg
Socket for CPU & Power Module				
	Zone 2 simplex, 3 slots for mounting / installing 1 x CPU and 2 x power module or 2 x CPU und 1 x power module Dimensions: approx. L = 167 mm, W = 96 mm, H = 50.6 mm	246871 ▲	22	0.400
	Zone 2 redundant, 4 slots for mounting / installing 2 x CPU and 2 x power module Dimensions: approx. L = 167 mm, W = 152 mm, H = 50.6 mm	262392	22	0.600
Fieldbus Isolating Repeater Series 9185/12				
	Equipment for installation in safe areas or Zone 2 / Div. 2 For fieldbuses with RS-485 interface. Suitable for PROFIBUS DP, Modbus, R. STAHL service bus. RS-232, RS-422, RS-485 interface with the automation system Transmission rate automatically set with PROFIBUS DP Adjustable transmission rate (1.2 kbit/s to 1.5 Mbit/s) 24 V AC/DC auxiliary power For further information, see data sheet for 9185/12 series	227600 ▲	21	0.350
Optical Fieldbus Isolating Repeater, Zone 2 / Div. 2				
	Isolating repeater for installation in Zone 2 / Div. 2 For fieldbus via fibre optic intrinsically safe cables "ex op is" into Zone 1 / Div. 1 Optical ring possible Extensive diagnostic function and fault-contact Suitable for Profibus DP up to 1.5 MBit/s Further versions and information see data sheet of Series 9186 optical fieldbus-isolating repeater	160624 ▲	25	0.244
Media converter FX op is / TX SC for Zone 2				
	Media Converter of 10/100 Base-Tx (1 x RJ45 port) to 100 Base-Fx "Ex op is" (1 x FO port SC); Multi mode (up to 4 km range); Webcode: 9721A	220381 ▲	75	0.240
Unmanaged Switch FX op is / TX SC				
	Unmanaged Switch FX op is to TX; SC plug connector FO cable 4 multi mode (MM), 2 RJ45, Installation in Zone 2	243427 ▲	75	0.500

Accessories				
Figure	Description	Art. No.	PS	Weight kg
Device DTM IS1+ for PROFIBUS DP and Ethernet				
	Parameterization and configuration of the IS1+ system Communicating with HART-compatible field devices Supports all common FDT frame applications (e.g. FieldCare, PactWare™) Condition Monitoring Scan function for automatic topology generation Download at r-stahl.com	-	-	-
IS1 PCS7 APL field device library				
	Easy connection of IS1+ modules to the SIEMENS control system PCS7 via PROFIBUS DP. The library contains CFC driver modules created in conformance with PCS7 modules, and documentation in English. HOTLINE support inclusive. Order, processing and support are carried out directly via SIEMENS: function.blocks.industry@siemens.com Hardware/software requirements: SIEMENS PCS7 V7.1 to 8 SP2 and IS1+ CPM 9440/...C1455 from V03.45 and GSD from V03.05	-	-	-
USB Converter				
	USB RS485 converter for installation in Zone 2. Noise insensitive, bidirectional conversion of USB data to RS485 serial data with power supply via USB port. Can be used for various applications, e.g. for missing RS485 interfaces to PCs. For further information, see data sheet for Series 9787 - Webcode 9787A	266011	75	0.170
USB Cable				
	Cable type: USB 2 5-pole with shielding Connector plug: USB type A / USB type A Temperature range: -40 °C ... +85 °C Cable colour: black Length: 2,5 m	268119	Z2	-

A4

Dimensional Drawings (All Dimensions in mm [inches]) – Subject to Alterations

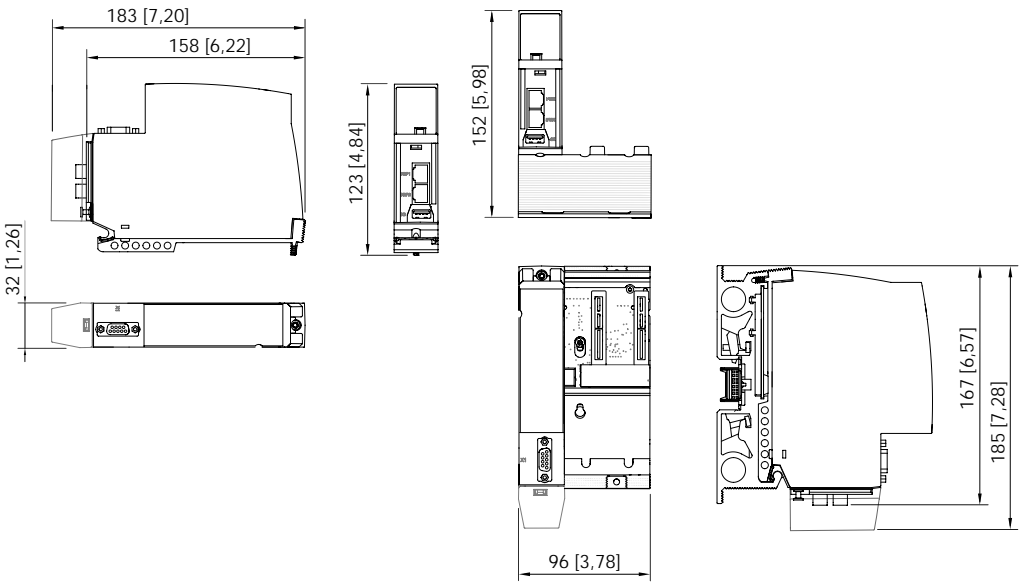

CPU Module 9442/35 + Base 9496/35

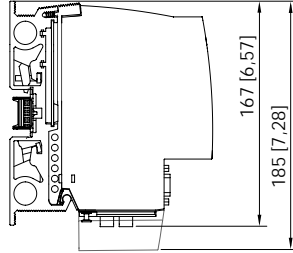
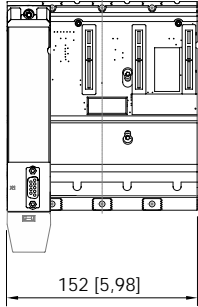
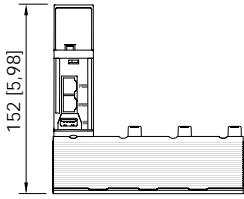

A4

CPU Module 9442/35 + Base 9496/35-04-00



- 24 V DC supply module for IS1+ CPU modules and 16 I/O modules
- Redundancy of the power module with load sharing possible
- Integrated polarity reversal protection
- Error messages in accordance with NE 107 (overload, excess temperature, maintenance requirements)
- Support of FDT/DTM and Webserver for integration in asset management systems
- Expanded ambient temperature range -40 °C to +75 °C

A4

WebCode **9445A**



The 9445/35 power module is used for intrinsically safe power supply to the 9442/35 CPU and up to 16 I/O modules. The auxiliary power connection is established using an extendable terminal with unconnected cable end (accessories). Up to two 9445/35 power modules can be connected to a 9496/35 base to provide a redundant power supply for the 9442/35 CPU and the I/O modules. The 9445/35 power module monitors itself and reports notifications to the control system and asset management systems when there is an overload, the ambient temperatures are too high or the end of the service life has been reached

	ATEX / IECEx					
	0	1	2	20	21	22
Zone						
Ex interface			•			
Installation in			•			

	NEC 505						NEC 506						
	Class I						Class I						
	0	1	2	20	21	22	0	1	2	20	21	22	
Zone													
Ex interface			•										
Installation in			•										

	NEC 500					
	Class I		Class II		Class III	
	1	2	1	2	1	2
Division						
Ex interface		•		•		•
Installation in		•				

Selection Table				
Installation	Zone 2			
Auxiliary power nominal voltage	Product Type		Art. No.	PS
24 V DC	9445/35-12		257290 ▲	22

Please order the 9442/35 power module, 9496/35 base and 24 V auxiliary power set (see accessories) separately.

Technical Data	
Explosion Protection	
IECEx gas explosion protection	Ex ec [ia Ga, ib Gb] IIC T4 Gc
ATEX gas explosion protection	⊕ II 3 (1,2) G Ex ec [ia Ga, ib Gb] IIC T4 Gc
EAC gas explosion protection	Ex 2 Ex e [ia Ga] [ib Gb] IIC T4 Gc X Ex 2 Ex nA ia [ia Ga] [ib Gb] IIC T4 Gc X
Certificates	ATEX (PTB), Canada (FM), EAC (Sertium), IECEx (PTB), USA (FM)
Auxiliary Power	
Auxiliary power voltage range	19 ... 32 V DC
Polarity reversal protection	Yes
Auxiliary power	Connection: 2-pole via a pluggable terminal with a 3 m single core
Redundancy	Yes (by using two power modules)
Ambient Conditions	
Ambient temperature	-40°C ... +65°C (without mounting plate) -40°C ... +70°C with 3 mm mounting plate sheet steel) -40°C ... +75°C (with 6 mm mounting plate aluminium)

Technical Data

Ambient Conditions	
Storage temperature	-40°C ... +80°C
Mechanical Data	
Degree of protection IP (IEC 60529)	IP30

Accessories

Figure	Description	Art. No.	PS	Weight kg
Connection set				
	Power supply set 24 V (3 m)	261232 ▲	Z2	0.100
Socket for CPU & Power Module				
	Zone 2 simplex, 3 slots for mounting / installing 1 x CPU and 2 x power module or 2 x CPU und 1 x power module Dimensions: approx. L = 167 mm, W = 96 mm, H = 50.6 mm	246871 ▲	Z2	0.400
	Zone 2 redundant, 4 slots for mounting / installing 2 x CPU and 2 x power module Dimensions: approx. L = 167 mm, W = 152 mm, H = 50.6 mm	262392	Z2	0.600

Dimensional Drawings (All Dimensions in mm [inches]) – Subject to Alterations

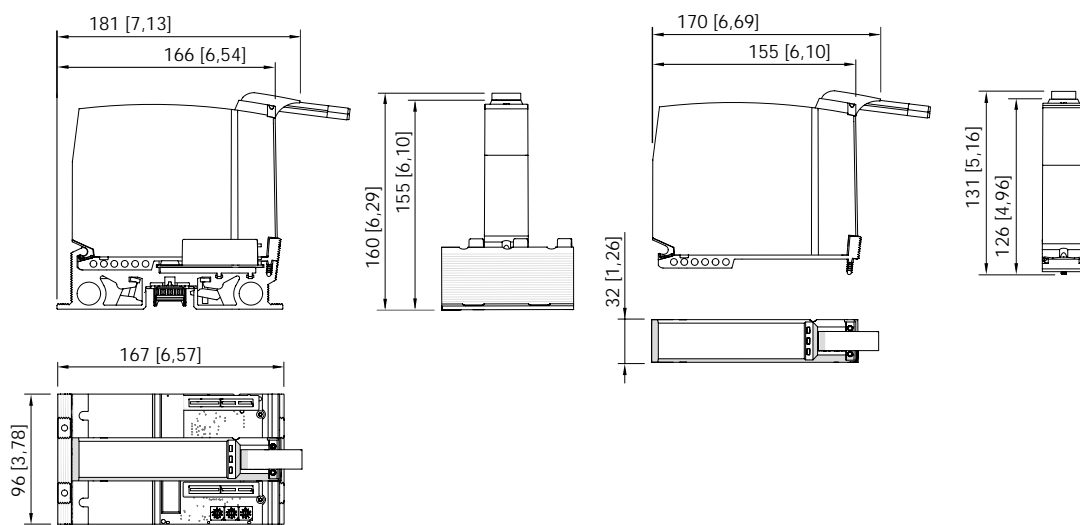

CPU Module 9445/35 with base 9496/35-03-00

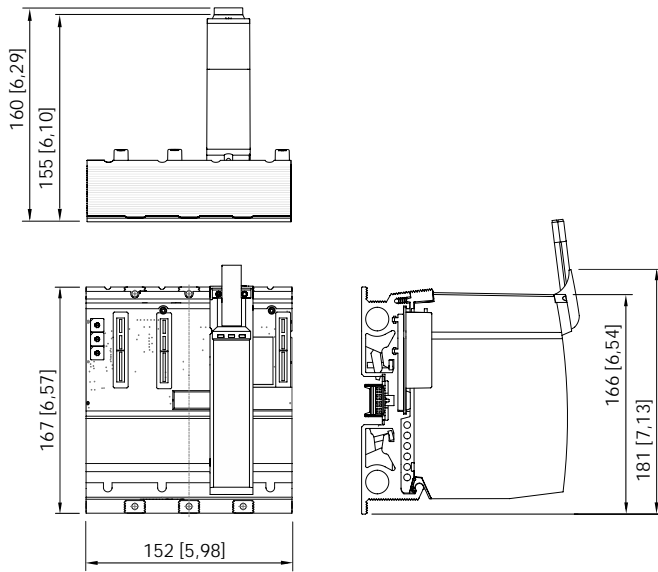

CPU Module 9445/35 with base 9496/35-04-00

A4



- Suitable for "op is" 100 Mbit/s Ethernet with PROFINET, Modbus TCP or Ethernet/IP™
- Redundant activation with Modbus TCP possible
- CPU can be hot swapped in Zone 1

A4

WebCode **9441A**



Modbus TCP



EtherNet/IP



The 9441/12 series CPU for Zone 1 is used to communicate with the automation system via PROFINET, Modbus TCP or Ethernet/IP™. The connection is established by means of an optically inherently safe "op is" fibre optic, which can be connected and disconnected in hazardous areas.

IS1+ and connected HART devices are integrated into asset management systems using a DTM.

	ATEX / IECEx						NEC 505 Class I						NEC 506						NEC 500									
	0	1	2	20	21	22	0	1	2	20	21	22	0	1	2	20	21	22	Class I	Class II	Class III	1	2	1	2	1	2	
Zone																												
Ex interface		•	•		•	•		•	•		•	•		•	•		•	•		•	•	•	•	•	•	•	•	•
Installation in		•	•		•	•		•	•		•	•		•	•		•	•		•	•	•	•	•	•	•	•	•

Selection Table						
Installation	Zone 1 / Division 1					
Protocols	Product Type			Art. No.	PS	Weight kg
EtherNet/IP Modbus TCP PROFINET	9441/12-00-00			211045 ▲	22	1.300

Please order the 9444/12 power module and base 9492/12 (see accessories) separately.

Technical Data	
Explosion Protection	
IECEx gas explosion protection	Ex d [ia Ga] [op is T6 Ga] IIC T4 Gb
IECEx dust explosion protection	[Ex ia Da] [Ex op is Da] IIIC
ATEX gas explosion protection	Ⓔ II 2 (1) G Ex d [ia Ga] [op is T6 Ga] IIC T4 Gb
ATEX dust explosion protection	Ⓔ II (1) D [Ex ia Da] [Ex op is Da] IIIC
EAC gas explosion protection	Ⓔ 1 Ex d [ia Ga] [op is T6 Ga] IIC T4 Gb X
EAC dust explosion protection	Ⓔ [Ex ia Da] [Ex op is Da] IIIC
Certificates	ATEX (DEK), Brazil (ULB), Canada (FM), EAC (STV), IECEx (DEK), International (FF), USA (FM)
Ship approval	ABS, CCS, ClassNK, DNVGL, RINA
Electrical Data	
Interface Ethernet	Fibre optic cable, 100BASE-FX, Ex op is (IEC 60079-28)
Transmission distance	2000 m
Transmission rate	max. 100 Mbit/s
Ethernet Connection	Multimode 62,5/125 µm (OM1) and 50/125 µm (OM3, OM4), plug LC

Technical Data	
Auxiliary Power	
Nominal voltage	24 V DC
Current consumption (without I/O modules)	0.36 A at 24 V DC
Current consumption (with 8 I/O modules)	Approx. 2.6 A at 24 V DC
Current consumption (with 16 I/O modules)	Approx. 4.9 A at 24 V DC
Power dissipation (without I/O modules)	8.6 W
Power dissipation (8 I/O modules)	14 W
Ambient Conditions	
Ambient temperature	-20°C ... +65°C
Mechanical Data	
Degree of protection IP (IEC 60529)	IP30

Accessories				
Figure	Description	Art. No.	PS	Weight kg
Device DTM IS1+ for PROFIBUS DP and Ethernet				
	Parameterization and configuration of the IS1+ system Communicating with HART-compatible field devices Supports all common FDT frame applications (e.g. FieldCare, PactWare™) Condition Monitoring Scan function for automatic topology generation Download at r-stahl.com	-	-	-
Socket for CPU and Power Module				
	Zone 1 Fieldbus: Modbus TCP, simplex 24 V DC	166176 ▲	22	1.100
	Zone 1 Fieldbus: EtherNet/IP™, simplex 24 V DC	166322 ▲	22	1.100
	Zone 1 Fieldbus: PROFINET, simplex 24 V DC	166321 ▲	22	1.100
	Zone 1 Fieldbus: Modbus TCP, redundant 24 V DC	166324	22	2.200
Media converter FX op is / TX SC for Zone 2				
	Media Converter of 10/100 Base-Tx (1 x RJ45 port) to 100 Base-Fx "Ex op is" (1 x FO port SC); Multi mode (up to 4 km range); Webcode: 9721A	220381 ▲	75	0.240
Unmanaged Switch FX op is / TX SC				
	Unmanaged Switch FX op is to TX: SC plug connector FO cable 4 multi mode (MM), 2 RJ45, Installation in Zone 2	243427 ▲	75	0.500
FO patch cable				
	Patch cable for connection of IS1+ Ethernet CPU 9441 and 9442 with media converter 9721; plug LC / SC; length 3 m	220911 ▲	22	-

Sockets and accessories for Div. 1 installation on request

Dimensional Drawings (All Dimensions in mm [inches]) – Subject to Alterations

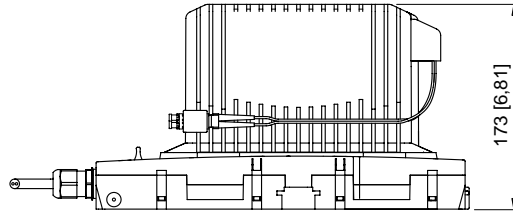
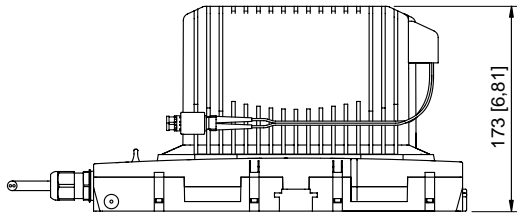

A4

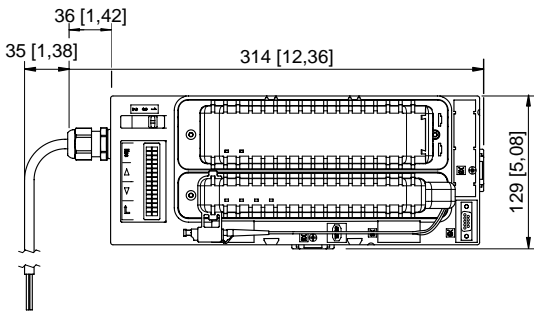

Ethernet CPU Module & Power Module with Socket for Zone 1

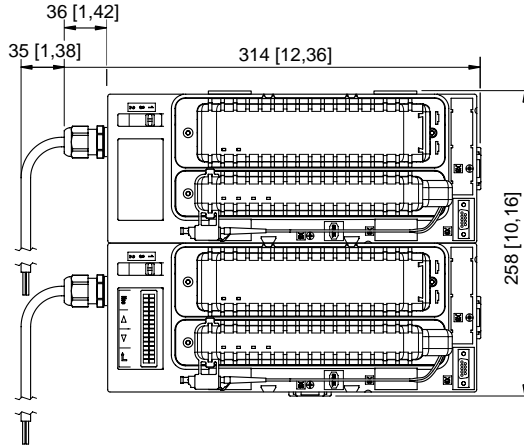

Ethernet CPU Module & Power Module with redundant Socket for Zone 1

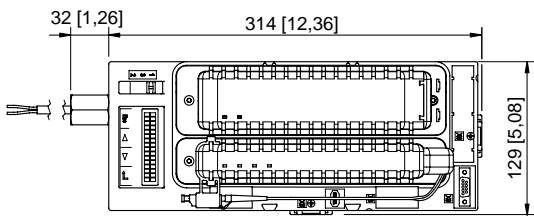
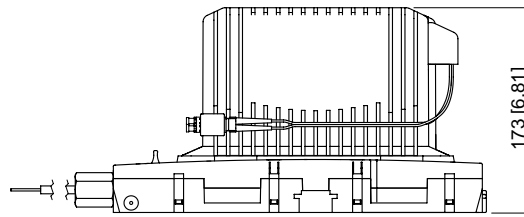
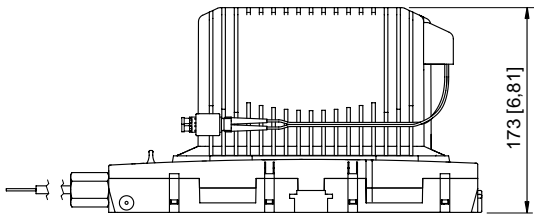

Ethernet CPU Module & Power Module with Socket for Div. 1

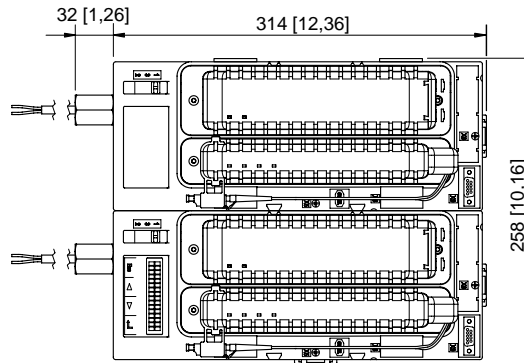

Ethernet CPU Module & Power Module with redundant Socket for Div. 1



- For intrinsically safe IS1+ system supply
- For up to eight IS1+ I/O modules and connected field devices
- Power module in Zone 1 can be hot swapped

A4

WebCode **9444A**



The series 9444/12 power module supplies up to eight IS1+ I/O modules, including the connected field circuits, with intrinsically safe energy. A 24 V DC external power supply is provided. The power module can be replaced while the system is in operation and without having to disconnect the power supply (i.e. hot swapped).

	ATEX / IECEx					
	0	1	2	20	21	22
Zone						
Ex interface		•	•		•	•
Installation in		•	•		•	•

	NEC 505 Class I			NEC 506		
	0	1	2	20	21	22
Zone						
Ex interface		•	•		•	•
Installation in		•	•		•	•

	NEC 500					
	Class I		Class II		Class III	
	1	2	1	2	1	2
Division						
Ex interface	•	•	•	•	•	•
Installation in	•	•	•	•	•	•

Selection Table							
Installation	Zone 1 / Division 1						
Nominal voltage	Product Type				Art. No.	PS	Weight kg
24 V DC	9444/12-11				166178 ▲	22	2.410
Please order the 9441/12 CPU and 9492/12 base (see accessories) separately.							

Technical Data	
Explosion Protection	
IECEx gas explosion protection	Ex d e [ia Ga] IIC T4 Gb
IECEx dust explosion protection	[Ex ia Da] IIIC
ATEX gas explosion protection	⊕ II 2 (1) G Ex d e [ia Ga] IIC T4 Gb
ATEX dust explosion protection	⊕ II (1) D [Ex ia Da] IIIC
EAC gas explosion protection	⊕ 1 Ex d e [ia Ga] IIC T4 Gb X
EAC dust explosion protection	⊕ [Ex ia Da] IIIC
Certificates	ATEX (DEK), Brazil (ULB), Canada (FM), EAC (STV), IECEx (DEK), USA (FM)
Ship approval	ABS, CCS, ClassNK, DNVGL, RINA
Auxiliary Power	
Current consumption (without I/O modules)	0.36 A at 24 V DC
Current consumption (with 8 I/O modules)	Approx. 2.6 A at 24 V DC
Power dissipation (without I/O modules)	8.6 W
Power dissipation (8 I/O modules)	14 W

Technical Data

Ambient Conditions	
Ambient temperature	-20°C ... +65°C
Storage temperature	-40°C ... +70°C

Mechanical Data

Degree of protection IP (IEC 60529)	IP30
-------------------------------------	------

Accessories

Figure	Description	Art. No.	PS	Weight kg
Socket for CPU and Power Module				
	Zone 1 Fieldbus: Modbus TCP, simplex 24 V DC	166176 ▲	22	1.100
	Zone 1 Fieldbus: PROFINET, simplex 24 V DC	166321 ▲	22	1.100
	Zone 1 Fieldbus: EtherNet/IP™, simplex 24 V DC	166322 ▲	22	1.100
	Zone 1 Fieldbus: Modbus TCP, redundant 24 V DC	166324	22	2.200

Sockets and accessories for Div. 1 installation on request

Dimensional Drawings (All Dimensions in mm [inches]) – Subject to Alterations

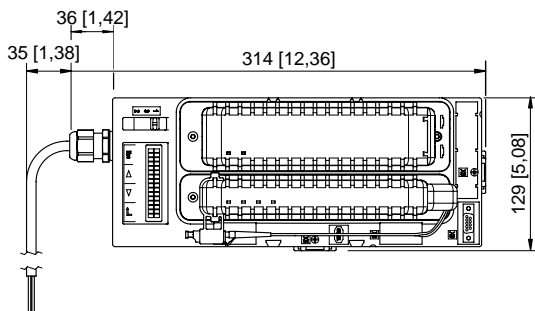
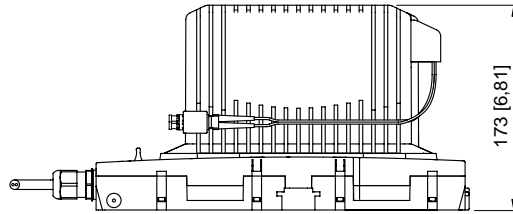
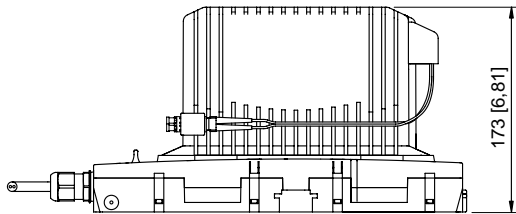

Ethernet CPU Module & Power Module with Socket for Zone 1

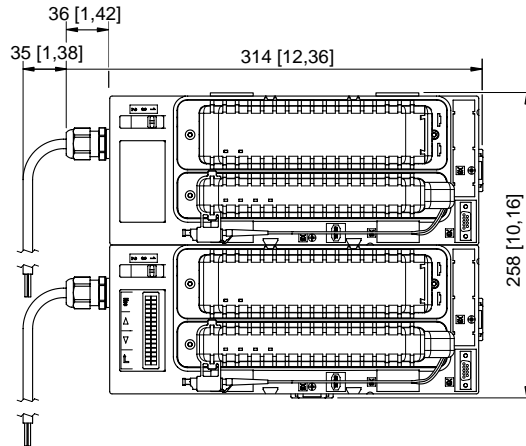

Ethernet CPU Module & Power Module with redundant Socket for Zone 1

Ethernet Power Module for Zone 1 / Div. 1

Series 9444/12

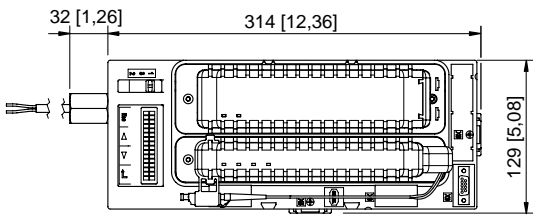
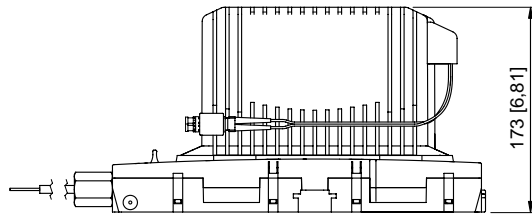
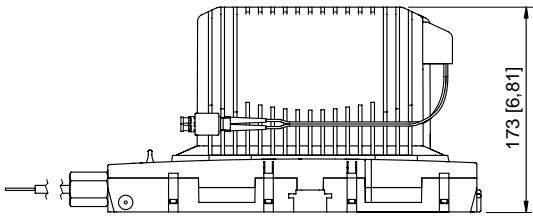

Ethernet CPU Module & Power Module with Socket for Div. 1

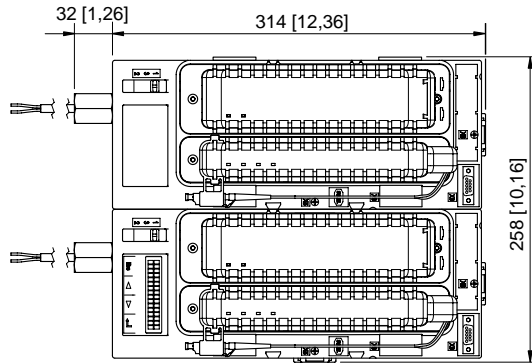

Ethernet CPU Module & Power Module with redundant Socket for Div. 1

A4



- Eight channels can be used individually as inputs or outputs
- Intrinsically safe Ex ia IIC inputs/outputs with line fault monitoring and LED error indication for each channel
- Module in Zone 1 can be hot swapped

A4

WebCode **9468A**



The 9468/32 series HART Analog Universal Module for Zone 1 has eight channels that can be used individually for Ex i operating two-/three-conductor HART transmitters, four-conductor transmitters or control valves/positioners with 0/4 to 20 mA signals. HART communication is bidirectional.

All inputs/outputs are short-circuit proof, galvanically separated from the system and individually monitored to check for line faults.

	ATEX / IECEx					
	0	1	2	20	21	22
Zone	•	•	•	•	•	•
Ex interface	•	•	•	•	•	•
Installation in	•	•	•	•	•	•

	NEC 505			NEC 506		
	Class I					
	0	1	2	20	21	22
Zone	•	•	•	•	•	•
Ex interface	•	•	•	•	•	•
Installation in	•	•	•	•	•	•

	NEC 500					
	Class I		Class II		Class III	
	1	2	1	2	1	2
Division	•	•	•	•	•	•
Ex interface	•	•	•	•	•	•
Installation in	•	•	•	•	•	•

Selection Table



Installation	Zone 1, Zone 2, Zone 21, Zone 22 and in the safe area					
Number of channels	Product Type			Art. No.	PS	Weight kg
8 Ex i inputs/outputs	9468/32-08-11			210659 ▲	22	0.275

Please order terminals separately - see accessories and spare parts.

Technical Data

Explosion Protection	
IECEx gas explosion protection	Ex ia [ia Ga] IIC T4 Gb
IECEx dust explosion protection	[Ex ia Da] IIIC
ATEX gas explosion protection	⊕ II 2 (1) G Ex ia [ia Ga] IIC T4 Gb
ATEX dust explosion protection	⊕ II (1) D [Ex ia Da] IIIC
EAC gas explosion protection	⊕ 2 Ex nA ia [ia Ga] IIC T4 Gc X
EAC dust explosion protection	⊕ [Ex ia Da] IIIC
Certificates	ATEX (DEK), Brazil (ULB), Canada (FM), EAC (STV), IECEx (DEK), India (PESO), Korea (KTL), Russia (Meteorological certificate), USA (FM)
Ship approval	ABS, CCS, ClassNK, DNVGL, RINA
Safety Data	
Maximum voltage U_o	24.4 V
Max. current I_o (2-conductor)	80 mA
Max. current I_o (3-conductor)	81.8 mA
Max. power P_o (2-conductor)	488 mW

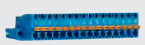
Technical Data	
Safety Data	
Max. power P_o (3-conductor)	499 mW
Electrical Data	
Number of channels	8 Ex i inputs/outputs
Channels	each with adjustable parameters as input or output (3-wire, 4-wire transmitters, or active mA-sources occupy 2 channels)
Nominal signal	4 ... 20 mA 0 ... 20 mA
Supply voltage	16 V, at 20 mA for 2-wire transmitters
Communication signal	HART protocol
Connection Ex i field signals	Pluggable, blue terminals, 16-pole, 2.5 mm ² , screw- or spring-type versions with lock
Notes	In order to operate an active 4-wire HART transmitter, a 9164 must be connected between each channel. 9164 is not required when operating 4-wire transmitter without HART communication.
Auxiliary Power	
Current consumption	220 mA (at 20 mA per channel)
Max. power consumption	5.3 W (at 20 mA / channel)
Max. power dissipation outputs	3.7 W (at 20 mA, 500 Ω / channel)
Max. power dissipation inputs	2.7 W (at 20 mA / channel)
Input	
Max. input resistance	14.1 Ω per channel
Output	
Output load resistance max.	750 Ω at 20 mA 700 Ω at 21.8 mA
Output step response (10 ... 90 %)	40 ms
Mechanical Data	
Degree of protection IP (IEC 60529)	IP20

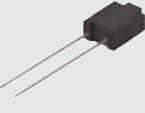
Accessories		Art. No.	PS	Weight kg
Pluggable terminal				
	2.5 mm ² with lock, 16-pole, screw connector, blue, for connecting the field signals to I/O modules, for intrinsically safe field circuits Labelling: 1 ... 16 Attention: An additional terminal is necessary for I/O module Series 9470 and 9482. Labelling: 17 ... 32	162702	Z2	0.028
	2.5 mm ² with lock, 16-pole, spring clamp connection, blue, for connecting the field signals to I/O modules, for intrinsically safe field circuits, incl. test jacks Labelling: 1 ... 16 Attention: An additional terminal is necessary for I/O module Series 9470 and 9482. Labelling: 17 ... 32	162695 ▲	Z2	0.028
mA-Isolating repeater				
	The mA isolating repeaters are used for the connection of 4-wire transmitters to active 2-wire inputs and for the galvanic separation. Input: sink, Ex e Output: sink, Ex i	224365 ▲	29	0.140
	The mA isolating repeaters are used for the connection of 4-wire transmitters to active 2-wire inputs and for the galvanic separation. Input: sink, Ex i Output: sink, Ex i	224364 ▲	29	0.090
Resistor error message suppression				
	The resistors are used to suppress error messages for unused I/O channels Resistance value: 5K6 / 0.5 W Suitable for: AIM 9468; DIOM 9470; DIOM 9471; DIOM 9472; DOM 9475 For intrinsically safe circuits (simple apparatus according to EN 60079-11)	244911	Z2	-
	The resistors are used to suppress error messages for unused I/O channels Resistance value: 62R / 0.5 W Suitable for: AOM 9468; TIM 9482	244912	Z2	-

Accessories

Figure	Description	Art. No.	PS	Weight kg
Labelling strips				
	FB Addr ... Mod No ..." for pluggable terminal, 26 pieces on the sheet	162788	Z2	0.001
DIN A4 sheet				
	For the label plate on I/O modules, 6 labels per sheet Print IS Wizard, packaging unit = 20 sheets	162832	Z2	0.001
Warning sign				
	"Clean modules only with a damp cloth."	162796	Z2	0.001
Partition				
	For mounting between intrinsically safe and non-intrinsically safe connections of the I/O modules, in order to adhere to the required 50 mm distance	220101 ▲	Z2	0.010

Dimensional Drawings (All Dimensions in mm [inches]) – Subject to Alterations

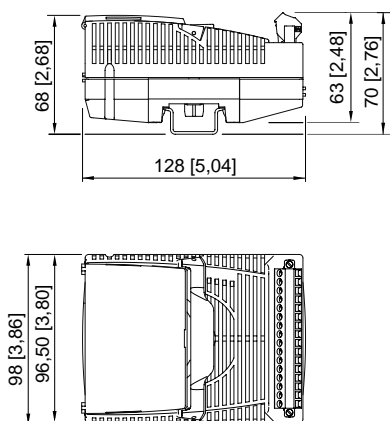



- Eight channels can be used individually as inputs or outputs
- Intrinsically safe Ex ia IIC inputs/outputs with line fault monitoring
- Module in Zone 2 can be hot swapped

A4

WebCode **9468B**



The 9468/33 series HART Analog Universal Module for Zone 2 has eight channels that can be used individually for Ex i operating two-/three-conductor HART transmitters, four-conductor transmitters or control valves/positioners with 0/4 to 20 mA signals. HART communication is bidirectional. All inputs/outputs are short-circuit proof, galvanically separated from the system and individually monitored to check for line faults.

	ATEX / IECEx					
Zone	0	1	2	20	21	22
Ex interface	•	•	•	•	•	•
Installation in			•			•

	NEC 505 Class I			NEC 506		
Zone	0	1	2	20	21	22
Ex interface	•	•	•	•	•	•
Installation in			•			•





	NEC 500					
	Class I		Class II		Class III	
Division	1	2	1	2	1	2
Ex interface	•	•	•	•	•	•
Installation in		•		•		•

Selection Table				
Installation	Zone 2, Zone 21, Zone 22 and in the safe area			
Number of channels	Product Type	Art. No.	PS	Weight kg
8 Ex i inputs/outputs	9468/33-08-10	210660 ▲	22	0.275

Please order terminals separately - see accessories and spare parts.

Technical Data	
Explosion Protection	
IECEx gas explosion protection	Ex nA ia [ia Ga] IIC T4 Gc
IECEx dust explosion protection	[Ex ia Da] IIIC
ATEX gas explosion protection	⊕ II 3 (1) G Ex nA ia [ia Ga] IIC T4 Gc
ATEX dust explosion protection	⊕ II (1) D [Ex ia Da] IIIC
EAC gas explosion protection	⊕ 2 Ex nA ia [ia Ga] IIC T4 Gc X
EAC dust explosion protection	⊕ [Ex ia Da] IIIC
Certificates	ATEX (DEK), Brazil (ULB), Canada (FM), EAC (STV), IECEx (DEK), India (PESO), Korea (KTL), Russia (Meteorological certificate), USA (FM)
Ship approval	ABS, CCS, ClassNK, DNVGL, RINA
Safety Data	
Maximum voltage U_o	24.4 V
Max. current I_o (2-conductor)	80 mA
Max. current I_o (3-conductor)	81.8 mA
Max. power P_o (2-conductor)	488 mW
Max. power P_o (3-conductor)	499 mW

Technical Data	
Electrical Data	
Number of channels	8 Ex i inputs/outputs
Channels	each with adjustable parameters as input or output (3-wire, 4-wire transmitters, or active mA-sources occupy 2 channels)
Nominal signal	4 ... 20 mA 0 ... 20 mA
Supply voltage	16 V, at 20 mA for 2-wire transmitters
Communication signal	HART protocol
Connection Ex i field signals	Pluggable, blue terminals, 16-pole, 2.5 mm ² , screw- or spring-type versions with lock
Notes	In order to operate an active 4-wire HART transmitter, a 9164 must be connected between each channel. 9164 is not required when operating 4-wire transmitter without HART communication.
Auxiliary Power	
Current consumption	220 mA (at 20 mA per channel)
Max. power consumption	5.3 W (at 20 mA / channel)
Max. power dissipation outputs	3.7 W (at 20 mA, 500 Ω / channel)
Max. power dissipation inputs	2.7 W (at 20 mA / channel)
Input	
Max. input resistance	14.1 Ω per channel
Output	
Output load resistance max.	750 Ω at 20 mA 700 Ω at 21.8 mA
Output step response (10 ... 90 %)	40 ms
Mechanical Data	
Degree of protection IP (IEC 60529)	IP20

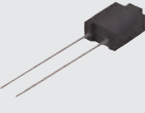
Accessories				
Figure	Description	Art. No.	PS	Weight kg
Pluggable terminal				
	2.5 mm ² with lock, 16-pole, screw connector, blue, for connecting the field signals to I/O modules, for intrinsically safe field circuits Labelling: 1 ... 16 Attention: An additional terminal is necessary for I/O module Series 9470 and 9482. Labelling: 17 ... 32	162702	Z2	0.028
	2.5 mm ² with lock, 16-pole, spring clamp connection, blue, for connecting the field signals to I/O modules, for intrinsically safe field circuits, incl. test jacks Labelling: 1 ... 16 Attention: An additional terminal is necessary for I/O module Series 9470 and 9482. Labelling: 17 ... 32	162695 ▲	Z2	0.028
mA-Isolating repeater				
	The mA isolating repeaters are used for the connection of 4-wire transmitters to active 2-wire inputs and for the galvanic separation. Input: sink, Ex e Output: sink, Ex i	224365 ▲	29	0.140
	The mA isolating repeaters are used for the connection of 4-wire transmitters to active 2-wire inputs and for the galvanic separation. Input: sink, Ex i Output: sink, Ex i	224364 ▲	29	0.090
Resistor error message suppression				
	The resistors are used to suppress error messages for unused I/O channels Resistance value: 5K6 / 0.5 W Suitable for: AIM 9468; DIOM 9470; DIOM 9471; DIOM 9472; DOM 9475 For intrinsically safe circuits (simple apparatus according to EN 60079-11)	244911	Z2	-
	The resistors are used to suppress error messages for unused I/O channels Resistance value: 62R / 0.5 W Suitable for: AOM 9468; TIM 9482	244912	Z2	-

Accessories				
Figure	Description	Art. No.	PS	Weight kg
Labelling strips				
	FB Addr ... Mod No ..." for pluggable terminal, 26 pieces on the sheet	162788	Z2	0.001
DIN A4 sheet				
	For the label plate on I/O modules, 6 labels per sheet Print IS Wizard, packaging unit = 20 sheets	162832	Z2	0.001
Warning sign				
	"Clean modules only with a damp cloth."	162796	Z2	0.001
Partition				
	For mounting between intrinsically safe and non-intrinsically safe connections of the I/O modules, in order to adhere to the required 50 mm distance	220101 ▲	Z2	0.010

A4

Dimensional Drawings (All Dimensions in mm [inches]) – Subject to Alterations

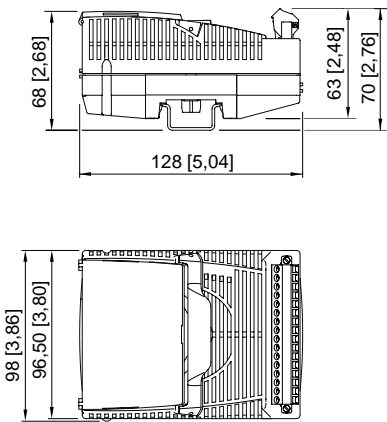



- 8 channels can be used as analogue inputs or outputs, and 4 of these channels can be used as binary inputs or outputs
- Ex nA inputs/outputs with line fault monitoring, an LED fault and status display for each channel and SIL2 shutdown input
- Module in Zone 2 can be replaced during operation (hot swap)

A4

WebCode **9469A**



The HART 9469/35 universal module for Zone 2 has 8 channels that are suitable for separately operating 2-/3-/4-line HART transmitters, control valves/position regulators and operating 3-line proximity switches and binary 24 V / 0.5 A outputs.

Signals can be used. HART communication is bidirectional. All inputs/outputs are short-circuit proof, galvanically separated from the system and individually monitored to check for line faults.

	ATEX / IECEx					
	0	1	2	20	21	22
Zone						
Ex interface			•			
Installation in			•			

	NEC 505 Class I			NEC 506		
	0	1	2	20	21	22
Zone						
Ex interface			•			
Installation in			•			

	NEC 500					
	Class I		Class II		Class III	
	1	2	1	2	1	2
Division						
Ex interface		•				
Installation in		•				

Selection Table

Installation	Zone 2, Zone 22 and in the safe area (non-intrinsically safe field circuits)				
Number of channels	Product Type		Art. No.	PS	Weight kg
(adjustable parameters in pairs) 8 Ex ec/nA universal input/output	9469/35-08-12		230184 ▲	22	0.250

Please order terminal separately - see accessories and spare parts

Technical Data

Explosion Protection	
IECEx gas explosion protection	Ex ec/nA ic [ia Ga] IIC T4 Gc
ATEX gas explosion protection	Ⓔ II 3 (1) G Ex ec/nA ic [ia Ga] IIC T4 Gc
EAC gas explosion protection	Ex 2 Ex e ic [ia Ga] IIC T4 Gc X Ex 2 Ex nA ic [ia Ga] IIC T4 Gc X
Certificates	ATEX (DEK), Canada (FM), EAC (Sertium), IECEx (DEK), Korea (KTL), SIL (exida), USA (FM)
Electrical Data	
Max. number of 2-conductor analogue inputs/ outputs	8 (channels 0 ... 7)
Max. number of 3/4-conductor analogue inputs	4 (channels 4 ... 7)
Max. number of 3-conductor PNP inputs	4 (channels 4 ... 7)
Max. number of binary outputs	4 (channels 4 ... 7)
Analogue digital communication	HART protocol
Digital communication note	up to Version 7.x, only at 4 to 20 mA
External supply voltage U _n (X0)	18 ... 32 V DC (nominal voltage of 24 V)

Technical Data	
Electrical Data	
Max. current consumption (X0)	4 x 0.5 A (depends on the total current of the binary outputs)
Control input suitability (X0)	Disconnection up to SIL 2. low demand (IEC 61508)
Control input function (X0)	"Plant STOP" to switch off all outputs
Auxiliary Power	
Power supply connection	BusRail types 9494
Auxiliary power version	Intrinsically safe Ex ia via BusRail
Current consumption	250 mA
Max. power consumption	6 W
Max. power dissipation outputs	5.9 W
Input	
Analogue input signal type	2/3/4-conductor transmitter
Analogue input nominal signal	0 ... 20 mA 4 ... 20 mA
Analogue input max. input resistance	200 Ω per channel
Binary input signal type	3-conductor PNP initiators 2-conductor 24 V contacts
Binary input signal type	corresponds to the ext. supply voltage U_H (X0)
Binary input internal resistance	11 kΩ
Output	
Analogue output signal type	2-conductor transmitter
Analogue output nominal signal	0 ... 20 mA 4 ... 20 mA
Analogue output max. input resistance	200 Ω per channel
Analogue output max. load resistance	750 Ω at 20 mA 700 Ω at 21.8 mA
Binary output signal type	2-conductor (24 V / 0.5 A)
Binary output supply voltage	corresponds to the ext. supply voltage U_H - 0.7 V (X0)
Binary output output current	30 mA ... 0.5 A per channel (electronically limited)
Binary output connectable loads	ohmic inductive capacitive
Mechanical Data	
Degree of protection IP (IEC 60529)	IP20

Accessories				
Figure	Description	Art. No.	PS	Weight kg
Plug-in terminal				
	1.5 mm² with lock, 24-pole, spring clamp connection, black for connecting the field signals to I/O modules, for non-intrinsically safe field circuits Caution: only for 9469, 9471 and 9472 I/O modules Labelling: 1 ... 24	245090 ▲	Z2	-
	1.5 mm² with lock, 24-pole, spring clamp connection, black for connecting the field signals to I/O modules, for non-intrinsically safe field circuits Caution: only for 9469, 9471 and 9472 I/O modules Labelling: 25 ... 48	245091 ▲	Z2	-
Resistor error message suppression				
	The resistors are used to suppress error messages for unused I/O channels Resistance value: 5K6 / 0.5 W Suitable for: AIM 9468; DIOM 9470; DIOM 9471; DIOM 9472; DOM 9475 For intrinsically safe circuits (simple apparatus according to EN 60079-11)	244911	Z2	-
	The resistors are used to suppress error messages for unused I/O channels Resistance value: 62R / 0.5 W Suitable for: AOM 9468; TIM 9482	244912	Z2	-

Accessories

Figure	Description	Art. No.	PS	Weight kg
Labelling strips				
	FB Addr ... Mod No ..." for pluggable terminal, 26 pieces on the sheet	162788	Z2	0.001
DIN A4 sheet				
	For the label plate on I/O modules, 6 labels per sheet Print IS Wizard, packaging unit = 20 sheets	162832	Z2	0.001
Partition				
	For mounting between intrinsically safe and non-intrinsically safe connections of the I/O modules, in order to adhere to the required 50 mm distance	220101 ▲	Z2	0.010
Warning sign				
	"Clean modules only with a damp cloth."	162796	Z2	0.001

Dimensional Drawings (All Dimensions in mm [inches]) – Subject to Alterations

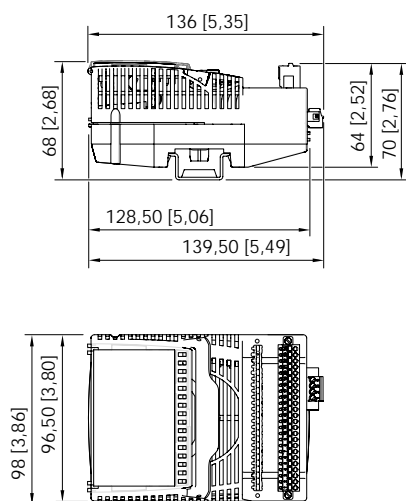



- Sixteen channels can be used in pairs as inputs or outputs
- Intrinsically safe Ex ia IIC inputs/outputs with line fault monitoring and LED error and status indication for each channel
- Module in Zone 1 can be hot swapped

A4

WebCode **9470C**



The 9470/32 series digital input/output module for Zone 1 has 16 channels, which can be used in pairs for Ex i operation as inputs for contacts and NAMUR proximity sensors (EN 60947-5-6) or as outputs for indicator lamps and low-power solenoid valves. Eight inputs can be used for frequencies of up to 20 kHz, and four can be used for detecting the direction of rotation.

All inputs/outputs are short-circuit proof and galvanically separated from the system.

	ATEX / IECEx					
	0	1	2	20	21	22
Zone						
Ex interface	•	•	•	•	•	•
Installation in		•	•		•	•









	NEC 505			NEC 506		
	Class I					
	0	1	2	20	21	22
Zone						
Ex interface		•	•	•	•	•
Installation in		•	•		•	•

	NEC 500					
	Class I		Class II		Class III	
	1	2	1	2	1	2
Division						
Ex interface	•	•	•	•	•	•
Installation in	•	•	•	•	•	•

Selection Table					
Installation	in Zone 1, Zone 2, Zone 21, Zone 22 and in safe areas				
Number of channels	Product Type		Art. No.	PS	Weight kg
(adjustable parameters in pairs) 16 Ex i inputs/outputs	9470/32-16-11		210447 ▲	22	0.275
Please order 2 terminals separately - see accessories and spare parts					

Technical Data	
Explosion Protection	
IECEx gas explosion protection	Ex ia [ia Ga] IIC T4 Gb
IECEx dust explosion protection	[Ex ia Da] IIIC
ATEX gas explosion protection	Ⓔ II 2 (1) G Ex ia [ia Ga] IIC T4 Gb
ATEX dust explosion protection	Ⓔ II (1) D [Ex ia Da] IIIC
EAC gas explosion protection	Ⓔ 1 Ex ia [ia Ga] IIC T4 Gb X
EAC dust explosion protection	Ⓔ [Ex ia Da] IIIC
Certificates	ATEX (DEK), Brazil (ULB), Canada (FM), EAC (STV), IECEx (DEK), India (PESO), Korea (KTL), USA (FM)
Ship approval	ABS, CCS, ClassNK, DNVGL, RINA
Safety Data	
Maximum voltage U ₀	9.8 V
Max. current I ₀ (Ex ia)	10.4 mA
Max. power P ₀ (Ex ia)	25.5 mW

Technical Data	
Auxiliary Power	
Current consumption	120 mA
Max. power consumption	2.5 W
Max. power dissipation outputs	2.5 W
Input	
Signal input	EN 60947 input (NAMUR)
Supply voltage	8.2 V
Function	Up/down counter Frequency with direction
Output	
Output rated operation	6 V / 2 mA
Notes	Output characteristic, see data sheet on the Internet r-stahl.com (WebCode 9470C)

Accessories				
Figure	Description	Art. No.	PS	Weight kg
Pluggable terminal				
	2.5 mm ² with lock, 16-pole, screw connector, blue, for connecting the field signals to I/O modules, for intrinsically safe field circuits Labelling: 1 ... 16 Attention: An additional terminal is necessary for I/O module Series 9470 and 9482. Labelling: 17 ... 32	162702	Z2	0.028
	2.5 mm ² with lock, 16-pole, screw connector, blue for connecting the field signals to I/O modules, for intrinsically safe field circuits Labelling: 17 ... 32	162718	Z2	0.028
	2.5 mm ² with lock, 16-pole, spring clamp connection, blue, for connecting the field signals to I/O modules, for intrinsically safe field circuits, incl. test jacks Labelling: 1 ... 16 Attention: An additional terminal is necessary for I/O module Series 9470 and 9482. Labelling: 17 ... 32	162695 ▲	Z2	0.028
	2.5 mm ² with lock, 16-pole, spring clamp connection, blue for connecting the field signals to I/O modules, for intrinsically safe field circuits, incl. test jacks Labelling: 17 ... 32	162716 ▲	Z2	0.028
Indicator lamp				
	Single electrical equipment for intrinsically safe circuits according to EN 60079-11	228026	18	0.035
Labelling strips				
	FB Addr ... Mod No ..." for pluggable terminal, 26 pieces on the sheet	162788	Z2	0.001
DIN A4 sheet				
	For the label plate on I/O modules, 6 labels per sheet Print IS Wizard, packaging unit = 20 sheets	162832	Z2	0.001
Partition				
	For mounting between intrinsically safe and non-intrinsically safe connections of the I/O modules, in order to adhere to the required 50 mm distance	220101 ▲	Z2	0.010

Accessories

Figure	Description	Art. No.	PS	Weight kg
Warning sign				
	"Clean modules only with a damp cloth."	162796	Z2	0.001
Resistor error message suppression				
	The resistors are used to suppress error messages for unused I/O channels Resistance value: 5K6 / 0.5 W Suitable for: AIM 9468; DIOM 9470; DIOM 9471; DIOM 9472; DOM 9475 For intrinsically safe circuits (simple apparatus according to EN 60079-11)	244911	Z2	-

A4

Dimensional Drawings (All Dimensions in mm [inches]) – Subject to Alterations

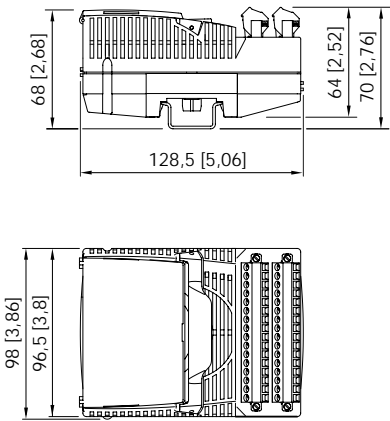

A4



- Sixteen channels can be used in pairs as inputs or outputs
- Intrinsically safe Ex ia IIC inputs/outputs with line fault monitoring
- Module in Zone 2 can be hot swapped

WebCode **9470D**



The 9470/33 series digital input/output module for Zone 2 has 16 channels, which can be used in pairs for Ex i operation as inputs for contacts and NAMUR proximity sensors (EN 60947-5-6) or as outputs for indicator lamps and low-power solenoid valves. Eight inputs can be used for frequencies of up to 20 kHz, and four can be used for detecting the direction of rotation.

All inputs/outputs are short-circuit proof and galvanically separated from the system.

	ATEX / IECEx					
Zone	0	1	2	20	21	22
Ex interface	•	•	•	•	•	•
Installation in			•		•	•

	NEC 505			NEC 506		
	Class I					
Zone	0	1	2	20	21	22
Ex interface			•	•	•	•
Installation in		•	•		•	•

	NEC 500					
	Class I		Class II		Class III	
Division	1	2	1	2	1	2
Ex interface	•	•	•	•	•	•
Installation in		•		•		•

Selection Table







Installation	in Zone 2, Zone 21, Zone 22 and in safe areas			
Number of channels	Product Type	Art. No.	PS	Weight kg
16 Ex i inputs/outputs (adjustable parameters in pairs)	9470/33-16-10	210448 ▲	22	0.275

Please order 2 terminals separately - see accessories and spare parts

Technical Data

Explosion Protection	
IECEx gas explosion protection	Ex nA ia [ia Ga] IIC T4 Gc
IECEx dust explosion protection	[Ex ia Da] IIIC
ATEX gas explosion protection	⊕ II 3 (1) G Ex nA ia [ia Ga] IIC T4 Gc
ATEX dust explosion protection	⊕ II (1) D [Ex ia Da] IIIC
EAC gas explosion protection	⊕ 2 Ex nA ia [ia Ga] IIC T4 Gc X
EAC dust explosion protection	⊕ [Ex ia Da] IIIC
Certificates	ATEX (DEK), Brazil (ULB), Canada (FM), EAC (STV), IECEx (DEK), India (PESO), Korea (KTL), USA (FM)
Ship approval	ABS, CCS, ClassNK, DNVGL, RINA
Safety Data	
Maximum voltage U ₀	9.8 V
Max. current I ₀ (Ex ia)	10.4 mA
Max. power P ₀ (Ex ia)	25.5 mW

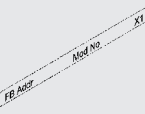
Technical Data	
Auxiliary Power	
Current consumption	120 mA
Max. power consumption	2.5 W
Max. power dissipation outputs	2.5 W
Input	
Signal input	EN 60947 input (NAMUR)
Supply voltage	8.2 V
Function	Frequency with direction Up/down counter
Output	
Output rated operation	6 V / 2 mA
Notes	Output characteristic, see data sheet on the Internet r-stahl.com (WebCode 9470D)

Accessories		Art. No.	PS	Weight kg
Pluggable terminal				
	2.5 mm ² with lock, 16-pole, screw connector, blue, for connecting the field signals to I/O modules, for intrinsically safe field circuits Labelling: 1 ... 16 Attention: An additional terminal is necessary for I/O module Series 9470 and 9482. Labelling: 17 ... 32	162702	Z2	0.028
	2.5 mm ² with lock, 16-pole, screw connector, blue for connecting the field signals to I/O modules, for intrinsically safe field circuits Labelling: 17 ... 32	162718	Z2	0.028
	2.5 mm ² with lock, 16-pole, spring clamp connection, blue, for connecting the field signals to I/O modules, for intrinsically safe field circuits, incl. test jacks Labelling: 1 ... 16 Attention: An additional terminal is necessary for I/O module Series 9470 and 9482. Labelling: 17 ... 32	162695 ▲	Z2	0.028
	2.5 mm ² with lock, 16-pole, spring clamp connection, blue for connecting the field signals to I/O modules, for intrinsically safe field circuits, incl. test jacks Labelling: 17 ... 32	162716 ▲	Z2	0.028
Indicator lamp				
	Single electrical equipment for intrinsically safe circuits according to EN 60079-11	228026	18	0.035
Labelling strips				
	FB Addr ... Mod No ..." for pluggable terminal, 26 pieces on the sheet	162788	Z2	0.001
DIN A4 sheet				
	For the label plate on I/O modules, 6 labels per sheet Print IS Wizard, packaging unit = 20 sheets	162832	Z2	0.001
Partition				
	For mounting between intrinsically safe and non-intrinsically safe connections of the I/O modules, in order to adhere to the required 50 mm distance	220101 ▲	Z2	0.010

Accessories

Figure	Description	Art. No.	PS	Weight kg
Warning sign				
	"Clean modules only with a damp cloth."	162796	Z2	0.001
Resistor error message suppression				
	The resistors are used to suppress error messages for unused I/O channels Resistance value: 5K6 / 0.5 W Suitable for: AIM 9468; DIOM 9470; DIOM 9471; DIOM 9472; DOM 9475 For intrinsically safe circuits (simple apparatus according to EN 60079-11)	244911	Z2	-

Dimensional Drawings (All Dimensions in mm [inches]) – Subject to Alterations

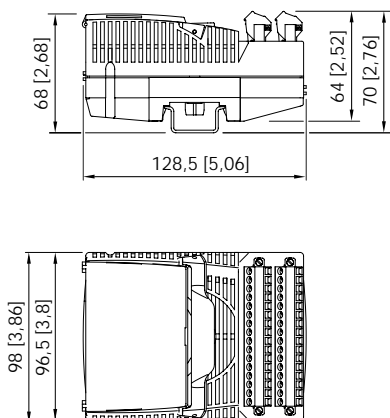



- Sixteen channels can be used in pairs as inputs or outputs
- Ex nA inputs/outputs with line fault monitoring and LED error and status indication for each channel
- Module in Zone 2 can be hot swapped

A4

WebCode **9471B**



The 9471/35 series digital input/output module for Zone 2 has 16 channels, which can be used in pairs for operation as inputs for contacts, NAMUR proximity sensors (EN 60947-5-6) and PNP proximity switches or as outputs for indicator lamps and low-power solenoid valves. Eight inputs can be used for frequencies of up to 20 kHz, and four can be used for detecting the direction of rotation.

All inputs/outputs are short-circuit proof and galvanically separated from the system.

	ATEX / IECEx					
	0	1	2	20	21	22
Zone						
Ex interface			•			
Installation in			•			

	NEC 505			NEC 506		
	Class I					
	0	1	2	20	21	22
Zone						
Ex interface			•			
Installation in			•			

	NEC 500					
	Class I		Class II		Class III	
	1	2	1	2	1	2
Division						
Ex interface		•				
Installation in		•				







Selection Table				
Installation	Zone 2, 22 and safe area			
Number of channels	Product Type	Art. No.	PS	Weight kg
(adjustable parameters in pairs) 16 Ex ec/nA inputs/outputs	9471/35-16-11	230225 ▲	22	0.275
Please order 2 terminals separately - see accessories and spare parts				

Technical Data	
Explosion Protection	
IECEx gas explosion protection	Ex ec/nA ic [ia Ga] IIC T4 Gc
ATEX gas explosion protection	Ⓔ II 3 (1) G Ex ec/nA ic [ia Ga] IIC T4 Gc
EAC gas explosion protection	Ex 2 Ex e ic [ia Ga] IIC T4 Gc X Ex 2 Ex nA ic [ia Ga] IIC T4 Gc
Certificates	ATEX (DEK), Canada (FM), EAC (Sertium), IECEx (DEK), India (PESO), Korea (KTL), USA (FM)
Electrical Data	
Max. number of 3-conductor PNP inputs	16 (channels 1... 15)
Auxiliary Power	
Current consumption	90 mA
Max. power consumption	2.2 W
Power dissipation max.	0.7 W
Input	
Max. number of frequency inputs	8 (channel 8 ... 15)

Technical Data

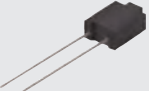
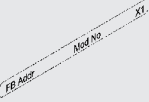
Input	
Notes	Max. supply voltage PNP: 24 V externally supplied
Output	
Notes	Output characteristics, see data sheet online at r-stahl.com (WebCode 9471B)
Mechanical Data	
Degree of protection IP (IEC 60529)	IP20

Accessories

Figure	Description	Art. No.	PS	Weight kg
Plug-in terminal				
	1.5 mm ² with lock, 24-pole, spring clamp connection, black for connecting the field signals to I/O modules, for non-intrinsically safe field circuits Caution: only for 9469, 9471 and 9472 I/O modules Labelling: 1 ... 24	245090 ▲	Z2	-
	1.5 mm ² with lock, 24-pole, spring clamp connection, black for connecting the field signals to I/O modules, for non-intrinsically safe field circuits Caution: only for 9469, 9471 and 9472 I/O modules Labelling: 25 ... 48	245091 ▲	Z2	-
Resistor error message suppression				
	The resistors are used to suppress error messages for unused I/O channels Resistance value: 5K6 / 0.5 W Suitable for: AIM 9468; DIOM 9470; DIOM 9471; DIOM 9472; DOM 9475 For intrinsically safe circuits (simple apparatus according to EN 60079-11)	244911	Z2	-
Labelling strips				
	FB Addr ... Mod No ..." for pluggable terminal, 26 pieces on the sheet	162788	Z2	0.001
DIN A4 sheet				
	For the label plate on I/O modules, 6 labels per sheet Print IS Wizard, packaging unit = 20 sheets	162832	Z2	0.001
Partition				
	For mounting between intrinsically safe and non-intrinsically safe connections of the I/O modules, in order to adhere to the required 50 mm distance	220101 ▲	Z2	0.010
Warning sign				
	"Clean modules only with a damp cloth."	162796	Z2	0.001

A4

Dimensional Drawings (All Dimensions in mm [inches]) – Subject to Alterations

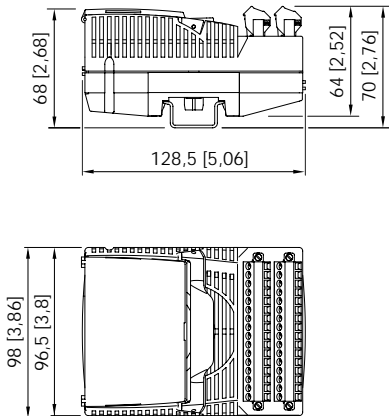

A4



- Sixteen channels can be used in pairs as inputs or outputs (24 V / 0.5 A)
- Ex nA inputs/outputs with line fault monitoring and LED error and status indication for each channel plus SIL 2 shutdown input
- Module in Zone 2 can be hot swapped

A4

WebCode **9472A**



The 9472/35 series 24 V digital input/output module for Zone 2 has 16 channels, which can be used in pairs for operation as inputs for contacts and PNP or NAMUR proximity sensors (EN 60947-5-6) or as outputs for solenoid valves up to 24 V/0.5 A. Eight inputs can be used for frequencies of up to 20 kHz, and four can be used for detecting the direction of rotation.

All inputs/outputs are short-circuit proof and galvanically separated from the system. Additional control input for "System OFF" (IEC61508 / through SIL2)

	ATEX / IECEx					
Zone	0	1	2	20	21	22
Ex interface			•			
Installation in			•			

	NEC 505 Class I			NEC 506		
Zone	0	1	2	20	21	22
Ex interface			•			
Installation in			•			

	NEC 500					
Division	Class I		Class II		Class III	
Division	1	2	1	2	1	2
Ex interface		•				
Installation in		•				

Selection Table

Installation	Zone 2	Art. No.	PS	Weight kg
Number of channels	Product Type			
16 Ex ec/nA inputs/outputs (adjustable parameters in pairs)	9472/35-16-12	230239 ▲	22	0.275

Please order 2 terminals separately - see accessories and spare parts

Technical Data

Explosion Protection	
IECEx gas explosion protection	Ex ec/nA ic [ia Ga] IIC T4 Gc
ATEX gas explosion protection	Ⓔ II 3 (1) G Ex ec/nA ic [ia Ga] IIC T4 Gc
EAC gas explosion protection	Ex 2 Ex e ic [ia Ga] IIC T4 Gc X Ex 2 Ex nA ic [ia Ga] IIC T4 Gc
Certificates	ATEX (DEK), Canada (FM), EAC (Sertium), IECEx (DEK), India (PESO), Korea (KTL), SIL (exida), USA (FM)
Electrical Data	
Max. number of 3-conductor PNP inputs	16 (channels 1... 15)
Auxiliary Power	
Current consumption	90 mA
Max. power consumption	2.2 W
Power dissipation max.	Output: 5.4 W Input: 1.4 W

Technical Data	
Input	
Max. number of frequency inputs	8 (channel 8 ... 15)
Control input suitability	Switch-off up to SIL 2, low demand (IEC61508)
Control input function	"Plant STOP" to switch off all outputs
Notes	Max. supply voltage PNP: corresponds to the external supply voltage U_n (X0) External supply voltage U_{II} (X0): 18 ... 32 V DC (nominal voltage 24 V) Max. current consumption (X0): 4 x 0.5 A (depending on the total current of the binary outputs)
Output	
Supply voltage binary	Corresponds to the ext. supply voltage U_n - 0.7 V (X0)
Output current binary	30 mA ... 0.5 A per channel (electronically limited)
Mechanical Data	
Degree of protection IP (IEC 60529)	IP20

Accessories				
Figure	Description	Art. No.	PS	Weight kg
Plug-in terminal				
	1.5 mm ² with lock, 24-pole, spring clamp connection, black for connecting the field signals to I/O modules, for non-intrinsically safe field circuits Caution: only for 9469, 9471 and 9472 I/O modules Labelling: 1 ... 24	245090 ▲	Z2	-
	1.5 mm ² with lock, 24-pole, spring clamp connection, black for connecting the field signals to I/O modules, for non-intrinsically safe field circuits Caution: only for 9469, 9471 and 9472 I/O modules Labelling: 25 ... 48	245091 ▲	Z2	-
Resistor error message suppression				
	The resistors are used to suppress error messages for unused I/O channels Resistance value: 5K6 / 0.5 W Suitable for: AIM 9468; DIOM 9470; DIOM 9471; DIOM 9472; DOM 9475 For intrinsically safe circuits (simple apparatus according to EN 60079-11)	244911	Z2	-
Labelling strips				
	FB Addr ... Mod No ..." for pluggable terminal, 26 pieces on the sheet	162788	Z2	0.001
DIN A4 sheet				
	For the label plate on I/O modules, 6 labels per sheet Print IS Wizard, packaging unit = 20 sheets	162832	Z2	0.001
Partition				
	For mounting between intrinsically safe and non-intrinsically safe connections of the I/O modules, in order to adhere to the required 50 mm distance	220101 ▲	Z2	0.010
Warning sign				
	"Clean modules only with a damp cloth."	162796	Z2	0.001

Dimensional Drawings (All Dimensions in mm [inches]) – Subject to Alterations

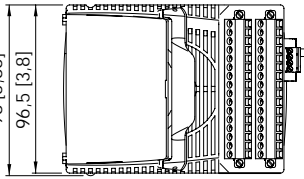
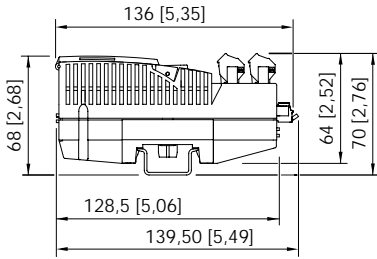

A4



- Eight channels for Ex i solenoid valves up to 30 mA
- Ex ia outputs with line fault monitoring and LED error and status indication for each channel plus SIL 2 shutdown input
- Modules in Zone 1 can be hot swapped

A4

WebCode **9475C**



9475/32-08 series digital output modules for Zone 1 have eight channels for actuating Ex i solenoid valves or indicator lamps. An additional Ex i control input is suitable for safe shutdown up to SIL 2. All outputs are short-circuit proof, galvanically separated from the system and individually monitored to check for wire breakage/short-circuiting.

	ATEX / IECEx					
Zone	0	1	2	20	21	22
Ex interface	•	•	•	•	•	•
Installation in		•	•		•	•

	NEC 505			NEC 506		
Zone	Class I					
Zone	0	1	2	20	21	22
Ex interface		•	•	•	•	•
Installation in		•	•		•	•







	NEC 500					
Division	Class I		Class II		Class III	
Division	1	2	1	2	1	2
Ex interface	•	•	•	•	•	•
Installation in	•	•	•	•	•	•



Selection Table						
Product variant	Digital output module with "Plant STOP"					
Installation	Zone 1, Zone 2, Zone 21, Zone 22 and in the safe area					
Open-circuit voltage U _o	Ex i output rated operation	Internal resistance of outputs	Product Type	Art. No.	PS	Weight kg
17.5 V	12.6 V/30 mA	170 Ω	9475/32-08-52	210655 ▲	22	0.275
23.5 V	17.5 V/20 mA	315 Ω	9475/32-08-62	210656 ▲	22	0.275

Please order terminals separately - see accessories and spare parts

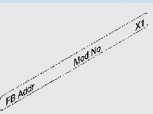
Technical Data		
Variant	9475/32-08-52	9475/32-08-62
Explosion Protection		
IECEX gas explosion protection	Ex ia [ia Ga] IIC T4 Gb	Ex ia [ia Ga] IIC T4 Gb
IECEX dust explosion protection	[Ex ia Da] IIIC	[Ex ia Da] IIIC
ATEX gas explosion protection	⊕ II 2 (1) G Ex ia [ia Ga] IIC T4 Gb	⊕ II 2 (1) G Ex ia [ia Ga] IIC T4 Gb
ATEX dust explosion protection	⊕ II (1) D [Ex ia Da] IIIC	⊕ II (1) D [Ex ia Da] IIIC
EAC gas explosion protection	⊕ 1 Ex ia [ia Ga] IIC T4 Gb X	⊕ 1 Ex ia [ia Ga] IIC T4 Gb X
EAC dust explosion protection	⊕ [Ex ia Da] IIIC	⊕ [Ex ia Da] IIIC
Certificates	ATEX (DEK), Brazil (ULB), Canada (FM), EAC (STV), IECEx (DEK), India (PESO), Korea (KTL), SIL (exida), USA (FM)	ATEX (DEK), Brazil (ULB), Canada (FM), EAC (STV), IECEx (DEK), India (PESO), Korea (KTL), SIL (exida), USA (FM)
Ship approval	ABS, CCS, ClassNK, DNVGL, RINA	ABS, CCS, ClassNK, DNVGL, RINA
Safety Data		
Maximum voltage U _o	19.4 V	25.7 V
Max. current I _o (Ex ia)	143 mA	107 mA

Technical Data		
Variant	9475/32-08-52	9475/32-08-62
Safety Data		
Max. current I ₀ (Ex ib)	37.8 mA	26.3 mA
Max. power P ₀ (Ex ia)	692 mW	688 mW
Max. power P ₀ (Ex ib)	506 mW	468 mW
Electrical Data		
Number of channels	8 Ex i outputs	8 Ex i outputs
Auxiliary Power		
Current consumption	250 mA	240 mA
Max. power consumption	6 W	5.8 W
Max. power dissipation outputs	4.8 W	4 W
Input		
Control input	Ex i control input X3	Ex i control input X3
Control input suitability	Switch-off up to SIL 2, low demand (IEC61508)	Switch-off up to SIL 2, low demand (IEC61508)
Control input function	"Plant STOP" to switch off all outputs	"Plant STOP" to switch off all outputs
Mechanical Data		
Degree of protection IP (IEC 60529)	IP20	IP20

Accessories				
Figure	Description	Art. No.	PS	Weight kg
Pluggable terminal				
	2.5 mm ² with lock, 16-pole, screw connector, blue, for connecting the field signals to I/O modules, for intrinsically safe field circuits Labelling: 1 ... 16 Attention: An additional terminal is necessary for I/O module Series 9470 and 9482. Labelling: 17 ... 32	162702	Z2	0.028
	2.5 mm ² with lock, 16-pole, spring clamp connection, blue, for connecting the field signals to I/O modules, for intrinsically safe field circuits, incl. test jacks Labelling: 1 ... 16 Attention: An additional terminal is necessary for I/O module Series 9470 and 9482. Labelling: 17 ... 32	162695 ▲	Z2	0.028
Electronic relay				
	The electronic relay module 9174 is used to switch Ex e loads by using intrinsically safe control signals. Input: Ex i Output: 48 V / 2 A DC, Ex e	212340 ▲	29	0.110
LED Indicator lamp Ex i				
	LED indicator lamp for intrinsically safe circuits 8010/3-02, Ex i	237972	18	0.035
Labelling strips				
	FB Addr ... Mod No ..." for pluggable terminal, 26 pieces on the sheet	162788	Z2	0.001
DIN A4 sheet				
	For the label plate on I/O modules, 6 labels per sheet Print IS Wizard, packaging unit = 20 sheets	162832	Z2	0.001

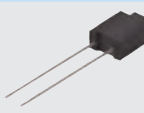
Accessories				
Figure	Description	Art. No.	PS	Weight kg
Partition				
	For mounting between intrinsically safe and non-intrinsically safe connections of the I/O modules, in order to adhere to the required 50 mm distance	220101 ▲	Z2	0.010
Warning sign				
	"Clean modules only with a damp cloth."	162796	Z2	0.001
Resistor error message suppression				
	The resistors are used to suppress error messages for unused I/O channels Resistance value: 5K6 / 0.5 W Suitable for: AIM 9468; DIOM 9470; DIOM 9471; DIOM 9472; DOM 9475 For intrinsically safe circuits (simple apparatus according to EN 60079-11)	244911	Z2	-

A4

Dimensional Drawings (All Dimensions in mm [inches]) – Subject to Alterations

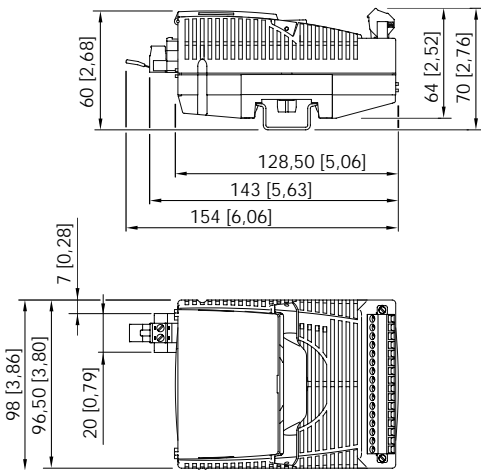



- Eight channels for Ex i solenoid valves up to 30 mA
- Ex ia outputs with line fault monitoring
- Modules in Zone 2 can be hot swapped

A4

WebCode **9475D**



9475/33-08 series digital output modules for Zone 2 have eight channels for actuating Ex i solenoid valves or indicator lamps. All outputs are short-circuit proof, galvanically separated from the system and individually monitored to check for wire breakage/short-circuiting.

	ATEX / IECEx					
	0	1	2	20	21	22
Zone						
Ex interface	•	•	•	•	•	•
Installation in			•			•

	NEC 505 Class I			NEC 506		
	0	1	2	20	21	22
Zone						
Ex interface			•	•	•	•
Installation in		•	•			•

	NEC 500					
	Class I		Class II		Class III	
	1	2	1	2	1	2
Division						
Ex interface	•	•	•	•	•	•
Installation in		•		•		•

Selection Table

Installation						
Zone 2, Zone 21, Zone 22 and in the safe area						
Open-circuit voltage U_o	Ex i output rated operation	Internal resistance of outputs	Product Type	Art. No.	PS	Weight kg
17.5 V	12.6 V/30 mA	170 Ω	9475/33-08-50	210657 ▲	22	0.275
23.5 V	17.5 V/20 mA	315 Ω	9475/33-08-60	210658 ▲	22	0.275

Please order terminals separately - see accessories and spare parts

Technical Data

Variant	9475/33-08-50	9475/33-08-60
Explosion Protection		
IECEx gas explosion protection	Ex nA ia [ia Ga] IIC T4 Gc	Ex nA ia [ia Ga] IIC T4 Gc
IECEx dust explosion protection	[Ex ia Da] IIIC	[Ex ia Da] IIIC
ATEX gas explosion protection	Ⓔ II 3 (1) G Ex nA ia [ia Ga] IIC T4 Gc	Ⓔ II 3 (1) G Ex nA ia [ia Ga] IIC T4 Gc
ATEX dust explosion protection	Ⓔ II (1) D [Ex ia Da] IIIC	Ⓔ II (1) D [Ex ia Da] IIIC
EAC gas explosion protection	Ⓔ 2 Ex nA ia [ia Ga] IIC T4 Gc X	Ⓔ 2 Ex nA ia [ia Ga] IIC T4 Gc X
EAC dust explosion protection	Ⓔ [Ex ia Da] IIIC	Ⓔ [Ex ia Da] IIIC
Certificates	ATEX (DEK), Brazil (ULB), Canada (FM), EAC (STV), IECEx (DEK), India (PESO), Korea (KTL), SIL (exida), USA (FM)	ATEX (DEK), Brazil (ULB), Canada (FM), EAC (STV), IECEx (DEK), India (PESO), Korea (KTL), SIL (exida), USA (FM)
Ship approval	ABS, CCS, ClassNK, DNVGL, RINA	ABS, CCS, ClassNK, DNVGL, RINA
Safety Data		
Maximum voltage U_o	19.4 V	25.7 V
Max. current I_o (Ex ia)	143 mA	107 mA
Max. current I_o (Ex ib)	37.8 mA	26.3 mA

Technical Data		
Variant	9475/33-08-50	9475/33-08-60
Safety Data		
Max. power P _o (Ex ia)	692 mW	688 mW
Max. power P _o (Ex ib)	506 mW	468 mW
Electrical Data		
Number of channels	8 Ex i outputs	8 Ex i outputs
Auxiliary Power		
Current consumption	250 mA	240 mA
Max. power consumption	6 W	5.8 W
Max. power dissipation outputs	4.8 W	4 W
Mechanical Data		
Degree of protection IP (IEC 60529)	IP20	IP20

Accessories				
Figure	Description	Art. No.	PS	Weight kg
Pluggable terminal				
	2.5 mm ² with lock, 16-pole, screw connector, blue, for connecting the field signals to I/O modules, for intrinsically safe field circuits Labelling: 1 ... 16 Attention: An additional terminal is necessary for I/O module Series 9470 and 9482. Labelling: 17 ... 32	162702	Z2	0.028
	2.5 mm ² with lock, 16-pole, spring clamp connection, blue, for connecting the field signals to I/O modules, for intrinsically safe field circuits, incl. test jacks Labelling: 1 ... 16 Attention: An additional terminal is necessary for I/O module Series 9470 and 9482. Labelling: 17 ... 32	162695 ▲	Z2	0.028
Electronic relay				
	The electronic relay module 9174 is used to switch Ex e loads by using intrinsically safe control signals. Input: Ex i Output: 48 V / 2 A DC, Ex e	212340 ▲	29	0.110
LED Indicator lamp Ex i				
	LED indicator lamp for intrinsically safe circuits 8010/3-02, Ex i	237972	18	0.035
Labelling strips				
	FB Addr ... Mod No ..." for pluggable terminal, 26 pieces on the sheet	162788	Z2	0.001
DIN A4 sheet				
	For the label plate on I/O modules, 6 labels per sheet Print IS Wizard, packaging unit = 20 sheets	162832	Z2	0.001
Partition				
	For mounting between intrinsically safe and non-intrinsically safe connections of the I/O modules, in order to adhere to the required 50 mm distance	220101 ▲	Z2	0.010

Accessories

Figure	Description	Art. No.	PS	Weight kg
Warning sign				
	"Clean modules only with a damp cloth."	162796	Z2	0.001
Resistor error message suppression				
	The resistors are used to suppress error messages for unused I/O channels Resistance value: 5K6 / 0.5 W Suitable for: AIM 9468; DIOM 9470; DIOM 9471; DIOM 9472; DOM 9475 For intrinsically safe circuits (simple apparatus according to EN 60079-11)	244911	Z2	-

Dimensional Drawings (All Dimensions in mm [inches]) – Subject to Alterations

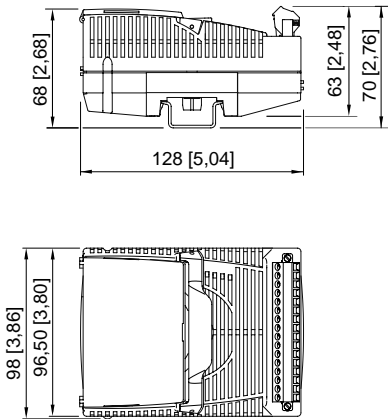



- 8 channels for pneumatic valves
- Pneumatic outputs with integrated 3/2-way valves and SIL 2 shut-down input
- Module in Zone 1 can be hot swapped

A4

WebCode **9478A**



The 9478 series digital output module valve for Zone 1 has eight channels for actuating pneumatic valves. The integrated 3/2-way solenoid valves are monitored to check for wire breakage and short-circuiting regardless of the drive status. An additional Ex i control input is suitable for safe shutdown up to SIL 2. Operation in combination with Ex i I/O modules is permissible.

	ATEX / IECEx					
Zone	0	1	2	20	21	22
Ex interface						
Installation in		•	•	•	•	

	NEC 505 Class I			NEC 506		
Zone	0	1	2	20	21	22
Ex interface		•	•			
Installation in				•	•	

	NEC 500					
	Class I		Class II		Class III	
Division	1	2	1	2	1	2
Ex interface						
Installation in	•	•				

Selection Table						
Product variant	Digital Output Module Valve for Zone 1					
Number of pneumatic valves	Pressure range min.	Max. pressure range	Product Type	Art. No.	PS	Weight kg
8 x 3/2-valves	2.5 bar	7 bar	9478/22-08-51	203599▲	22	0.950

Technical Data	
Explosion Protection	
IECEx gas explosion protection	Ex ib IIC T4
ATEX gas explosion protection	Ⓔ II 2 G Ex ib IIC T4
EAC gas explosion protection	Ⓔ 1 Ex ib IIC T4 Gb X
Certificates	ATEX (PTB), Brazil (ULB), Canada (FM), EAC (STV), IECEx (PTB), Korea (KTL), SIL (exida), USA (FM)
Ship approval	CCS, DNVGL, RINA
Auxiliary Power	
Max. power consumption	5.75 W with activated pilot valves
Undervoltage monitoring	All outputs are depressurized
Input	
Control input suitability	Switch-off up to SIL 2, low demand (IEC61508)
Control input function	System OFF, outputs are depressurized
Device Specific Data	
Pneumatic data media	Compressed air oiled Dry Neutral gasses (5 µm filter received) Oil-free
Pneumatic data manual actuation	Yes

Technical Data

Device Specific Data

Pneumatic data switching times	Approx. 1000 c.p.m.
Pneumatic data Qn value	300 l/min
Pneumatic data Qn value note	at 20 °C air temperature, 6 bar at the valve inlet and 1 bar of differential pressure
Pneumatic connections	P, R: plug connector Ø 8 mm Y0 ... Y7: plug connector Ø 6 mm X: standard silencer (included in the delivery and already fitted)

Mechanical Data

Degree of protection IP (IEC 60529)	IP20
Enclosure material	Polyamide 6GF
Sealing material	FPM, NBR
Material of valve block	PPS, PA

Dimensional Drawings (All Dimensions in mm [inches]) – Subject to Alterations

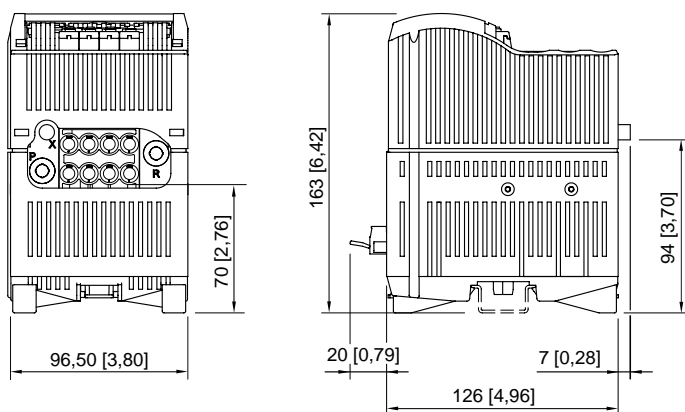



- Eight channels for resistance temperature detectors, potentiometers, thermocouples, mV sensors and joysticks
- Intrinsically safe Ex ia inputs with line fault monitoring and LED error indication
- Module in Zone 1 can be hot swapped

A4

WebCode **9482A**



The series 9482 temperature input module for Zone 1 has eight channels for the Ex i operation of resistance temperature detectors with two-, three- or four-conductor connection and thermocouples. Sensors that comply with DIN, IEC and GOST are supported as well as resistance transmitters up to 10 kΩ and also joysticks for rapid four-channel operation. Earthed thermocouples can be connected. Cold junction compensation can be performed internally or externally.

	ATEX / IECEx					
	0	1	2	20	21	22
Zone						
Ex interface	•	•	•	•	•	•
Installation in		•	•		•	•

	NEC 505 Class I			NEC 506		
	0	1	2	20	21	22
Zone						
Ex interface		•	•	•	•	•
Installation in		•	•		•	•

	NEC 500					
	Class I		Class II		Class III	
	1	2	1	2	1	2
Division						
Ex interface	•	•	•	•	•	•
Installation in	•	•	•	•	•	•

Selection Table					
Installation	Zones 1, 2, 21, 22 and in the safe area				
Number of channels	Product Type		Art. No.	PS	Weight kg
8 or 4 Ex i inputs (depends on operating mode)	9482/32-08-11		217643▲	22	0.275
Please order 2 terminals separately - see accessories and spare parts					

Technical Data	
Explosion Protection	
IECEx gas explosion protection	Ex ia [ia Ga] IIC T4 Gb
IECEx dust explosion protection	[Ex ia Da] IIIC
ATEX gas explosion protection	Ⓔ II 2 (1) G Ex ia [ia Ga] IIC T4 Gb
ATEX dust explosion protection	Ⓔ II (1) D [Ex ia Da] IIIC
EAC gas explosion protection	Ⓔ 1 Ex ia [ia Ga] IIC T4 Gb
EAC dust explosion protection	Ⓔ [Ex ia Da] IIIC
Certificates	ATEX (DEK), Brazil (ULB), Canada (FM), EAC (STV), IECEx (DEK), India (PESO), Korea (KTL), Russia (Meteorological certificate), USA (FM)
Ship approval	ABS, CCS, ClassNK, DNVGL, RINA
Safety Data	
Notes	For proof of intrinsic safety, the safety data must be used in accordance with the combination of connections and the corresponding sensor. For further information and combination, see operating instructions.

Technical Data

Auxiliary Power

Current consumption	42 mA
Max. power consumption	1 W
Max. power dissipation inputs	1 W

Input

Compensation of reference junctions	Internal (adjustable parameters) External 3-wire circuit
-------------------------------------	---

Mechanical Data

Degree of protection IP (IEC 60529)	IP20
-------------------------------------	------

Dimensional Drawings and connectable sensors see page 129

Accessories

Figure	Description	Art. No.	PS	Weight kg
Pluggable terminal				
	2.5 mm² with lock, 16-pole, screw connector, blue, for connecting the field signals to I/O modules, for intrinsically safe field circuits Labelling: 1 ... 16 Attention: An additional terminal is necessary for I/O module Series 9470 and 9482. Labelling: 17 ... 32	162702	Z2	0.028
	2.5 mm² with lock, 16-pole, screw connector, blue for connecting the field signals to I/O modules, for intrinsically safe field circuits Labelling: 17 ... 32	162718	Z2	0.028
	2.5 mm² with lock, 16-pole, spring clamp connection, blue, for connecting the field signals to I/O modules, for intrinsically safe field circuits, incl. test jacks Labelling: 1 ... 16 Attention: An additional terminal is necessary for I/O module Series 9470 and 9482. Labelling: 17 ... 32	162695 ▲	Z2	0.028
	2.5 mm² with lock, 16-pole, spring clamp connection, blue for connecting the field signals to I/O modules, for intrinsically safe field circuits, incl. test jacks Labelling: 17 ... 32	162716 ▲	Z2	0.028
Labelling strips				
	FB Addr ... Mod No ..." for pluggable terminal, 26 pieces on the sheet	162788	Z2	0.001
DIN A4 sheet				
	For the label plate on I/O modules, 6 labels per sheet Print IS Wizard, packaging unit = 20 sheets	162832	Z2	0.001
Partition				
	For mounting between intrinsically safe and non-intrinsically safe connections of the I/O modules, in order to adhere to the required 50 mm distance	220101 ▲	Z2	0.010
Warning sign				
	"Clean modules only with a damp cloth."	162796	Z2	0.001
Resistor error message suppression				
	The resistors are used to suppress error messages for unused I/O channels Resistance value: 62R / 0.5 W Suitable for: AOM 9468; TIM 9482	244912	Z2	-



- Eight channels for resistance temperature detectors, potentiometers, thermocouples, mV sensors and joysticks
- Intrinsically safe Ex ia inputs with line fault monitoring
- Module in Zone 2 can be hot swapped

A4

WebCode **9482B**



The 9482 series temperature input module for Zone 2 has eight channels for the Ex i operation of resistance temperature detectors with two-, three- or four-conductor connection and thermocouples. Sensors that comply with DIN, IEC and GOST are supported as well as resistance transmitters up to 10 kΩ and also joysticks for rapid four-channel operation. Earthed thermocouples can be connected. Cold junction compensation can be performed internally or externally.

	ATEX / IECEx					
	0	1	2	20	21	22
Zone						
Ex interface	•	•	•	•	•	•
Installation in			•			•

	NEC 505			NEC 506		
	Class I					
	0	1	2	20	21	22
Zone						
Ex interface			•	•	•	•
Installation in	•	•				•

	NEC 500					
	Class I		Class II		Class III	
	1	2	1	2	1	2
Division						
Ex interface	•	•	•	•	•	•
Installation in		•		•		•

Selection Table					
Installation	Zones 2, 22 and in the safe area				
Number of channels	Product Type		Art. No.	PS	Weight kg
(depends on operating mode) 8 or 4 Ex i inputs	9482/33-08-10		217644 ▲	22	0.275
Please order 2 terminals separately - see accessories and spare parts					

Technical Data	
Explosion Protection	
IECEx gas explosion protection	Ex nA ia [ia Ga] IIC T4 Gb
IECEx dust explosion protection	[Ex ia Da] IIIC
ATEX gas explosion protection	Ⓔ II 3 (1) G Ex nA ia [ia Ga] IIC T4 Gb
ATEX dust explosion protection	Ⓔ II (1) D [Ex ia Da] IIIC
EAC gas explosion protection	Ⓔ 2 Ex nA ia [ia Ga] IIC T4 Gc X
EAC dust explosion protection	Ⓔ [Ex ia Da] IIIC
Certificates	ATEX (DEK), Brazil (ULB), Canada (FM), EAC (STV), IECEx (DEK), India (PESO), Korea (KTL), Russia (Meteorological certificate), USA (FM)
Ship approval	ABS, CCS, ClassNK, DNVGL, RINA
Safety Data	
Notes	For proof of intrinsic safety, the safety data must be used in accordance with the combination of connections and the corresponding sensor. For further information and combination, see operating instructions.

Technical Data

Auxiliary Power

Current consumption	42 mA
Max. power consumption	1 W
Max. power dissipation inputs	1 W

Input

Compensation of reference junctions	Internal (adjustable parameters) External 3-wire circuit
-------------------------------------	---

Mechanical Data

Degree of protection IP (IEC 60529)	IP20
-------------------------------------	------

Connectable sensors see page 129

Accessories

Figure	Description	Art. No.	PS	Weight kg
Pluggable terminal				
	2.5 mm² with lock, 16-pole, screw connector, blue, for connecting the field signals to I/O modules, for intrinsically safe field circuits Labelling: 1 ... 16 Attention: An additional terminal is necessary for I/O module Series 9470 and 9482. Labelling: 17 ... 32	162702	Z2	0.028
	2.5 mm² with lock, 16-pole, screw connector, blue for connecting the field signals to I/O modules, for intrinsically safe field circuits Labelling: 17 ... 32	162718	Z2	0.028
	2.5 mm² with lock, 16-pole, spring clamp connection, blue, for connecting the field signals to I/O modules, for intrinsically safe field circuits, incl. test jacks Labelling: 1 ... 16 Attention: An additional terminal is necessary for I/O module Series 9470 and 9482. Labelling: 17 ... 32	162695 ▲	Z2	0.028
	2.5 mm² with lock, 16-pole, spring clamp connection, blue for connecting the field signals to I/O modules, for intrinsically safe field circuits, incl. test jacks Labelling: 17 ... 32	162716 ▲	Z2	0.028
Labelling strips				
	FB Addr ... Mod No ..." for pluggable terminal, 26 pieces on the sheet	162788	Z2	0.001
DIN A4 sheet				
	For the label plate on I/O modules, 6 labels per sheet Print IS Wizard, packaging unit = 20 sheets	162832	Z2	0.001
Partition				
	For mounting between intrinsically safe and non-intrinsically safe connections of the I/O modules, in order to adhere to the required 50 mm distance	220101 ▲	Z2	0.010
Warning sign				
	"Clean modules only with a damp cloth."	162796	Z2	0.001
Resistor error message suppression				
	The resistors are used to suppress error messages for unused I/O channels Resistance value: 62R / 0.5 W Suitable for: AOM 9468; TIM 9482	244912	Z2	-

Dimensional Drawings (All Dimensions in mm [inches]) – Subject to Alterations

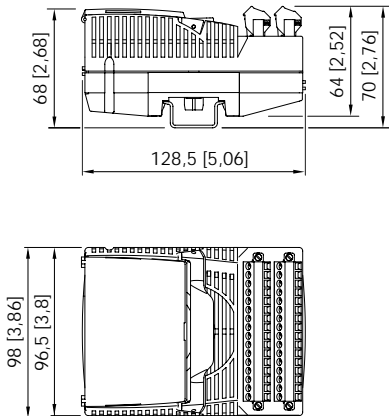

A4

Ex i Inputs

Connectable resistance temperature detectors / resistance transmitters	Type	Reference	Measuring range (ITS-90)	Medium resolution	
	Pt100	IEC 60751	200 ... +850 °C	0.1 K	
	Pt500	IEC 60751	-200 ... +850 °C	0.1 K	
	Pt1000	IEC 60751	-200 ... +850 °C	0.1 K	
	Ni100	DIN 43760	-60 ... +180 °C	0.1 K	
	Ni500	DIN 43760	-60 ... +180 °C	0.1 K	
	Ni1000	DIN 43760	-60 ... +180 °C	0.1 K	
	Pt46	GOST 6651-94	-200 ... +1100 °C	0.15 K	
	Pt50	GOST 6651-94	-200 ... +1100 °C	0.15 K	
	Pt100	GOST 6651-94	-200 ... +1100 °C	0.1 K	
	Cu53	GOST 6651-94	-50 ... +180 °C	0.1 K	
	M50	GOST 6651-94	-200 ... +200 °C	0.15 K	
	M100	GOST 6651-94	-200 ... +200 °C	0.1 K	
	Resistance transmitter (3-wire)	--	0 ... 500 Ω	0.02 Ω	
	Resistance transmitter (3-wire)	--	0 ... 2.5 kΩ	0.10 Ω	
	Resistance transmitter (3-wire)	--	0 ... 5 kΩ	0.20 Ω	
	Resistance transmitter (3-wire)	--	0 ... 10 kΩ	0.4 Ω	
	Resistance transmitter (3-wire)	--	-200 ... +850 °C	0.1 K	
	Joystick (4-wire)	--	500 ... 10 kΩ	0.1 K	
Connectable thermocouples / mV sensors	Type	Reference	Measuring range (ITS-90)	Medium resolution	Medium error of measurement with regard to measuring range
	B	IEC 60584-1	-400 ... +1800 °C	0.25 K	0.1 %
	E	IEC 60584-1	-200 ... +1000 °C	0.1 K	0.013 %
	J	IEC 60584-1	-200 ... +1200 °C	0.1 K	0.014 %
	K	IEC 60584-1	-200 ... +1370 °C	0.1 K	0.02 %
	N	IEC 60584-1	-200 ... +1300 °C	0.1 K	0.02 %
	R	IEC 60584-1	-50 ... +1767 °C	0.2 K	0.05 %
	S	IEC 60584-1	-50 ... +1767 °C	0.2 K	0.053 %
	T	IEC 60584-1	-200 ... +400 °C	0.1 K	0.042 %
	L	DIN 43710	-200 ... +900 °C	0.1 K	0.027 %
	U	DIN 43710	-200 ... +600 °C	0.1 K	0.038 %
	XK	GOST 8.585	-50 ... +800 °C	0.1 K	0.02 %
	mV	--	0 ... +100 mV	3.6 μV	0.01 %



- For the internal electrical connection between CPU & power module and up to 16 I/O modules
- Redundant data bus, power bus with high availability
- Simple, protected installation in NS35/15 DIN rails
- Passive component with redundancy and high availability

A4

WebCode **9494A**



The series 9494 bus rails are used as a backplane bus for the IS1+ remote I/O system. They include an Ex i power bus boasting high availability, a redundant Ex i data bus and address lines. The bus rails are available for 2 or 4 modules and can be combined for up to 18 slots. The BusRail extension cable can be used to place BusRail segments anywhere in the field enclosure.

	ATEX / IECEx					
Zone	0	1	2	20	21	22
Ex interface		•	•		•	•
Installation in		•	•		•	•

	NEC 505 Class I			NEC 506		
Zone	0	1	2	20	21	22
Ex interface	•	•	•	•	•	•
Installation in		•	•		•	•

	NEC 500					
	Class I		Class II		Class III	
Division	1	2	1	2	1	2
Ex interface	•	•	•	•	•	•
Installation in	•	•	•	•	•	•

Selection Table						
Remote I/O IS1+ BusRail						
Figure	Version	Product Type	Art. No.	PS	Weight kg	
	For 2 modules, beginning	9494/S1-B2	261798 ▲	22	0.062	
	For 2 modules, end	9494/S1-E2	261799 ▲	22	0.062	
	For 4 modules	9494/S1-M4	261800 ▲	22	0.100	
Remote I/O IS1+ BusRail connecting line						
Figure	Version	Product Type	Art. No.	PS	Weight kg	
	110 cm	9494/L1-V8	261796 ▲	22	0.260	

Technical Data	
Explosion Protection	
IECEx gas explosion protection	Ex ia IIC T4 Gb
ATEX gas explosion protection	Ⓔ II 2 G Ex ia IIC T4 Gb
EAC gas explosion protection	Ⓕ 1 Ex ia IIC T4 Gb X
Certificates	ATEX (PTB), Canada (FM), EAC (Sertium), IECEx (PTB), Korea (KTL), USA (FM)

Technical Data

Electrical Data

Engineering note

The BusRail is available in lengths for 2 or 4 modules. One end piece each is necessary at the beginning and the end. The end pieces are available as "BusRail beginning" and "BusRail end" as well as with an integrated connecting line. The connecting line allows for multiple BusRail segments to be set up in one enclosure.

Ambient Conditions

Ambient temperature -40°C ... +75°C

Dimensional Drawings (All Dimensions in mm [inches]) – Subject to Alterations

A4

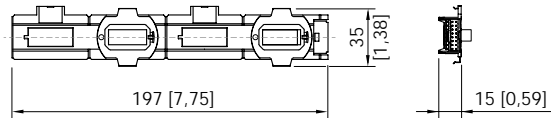

BusRail, beginning

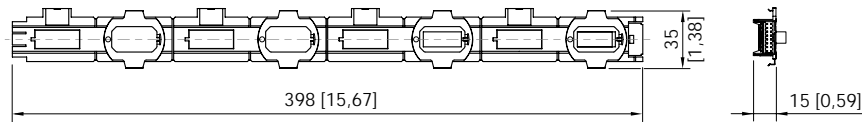

BusRail, centre

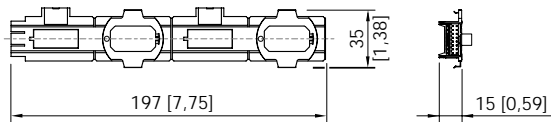

BusRail, end

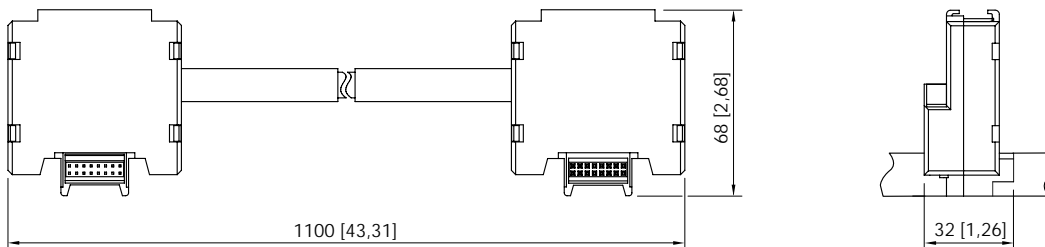



- Short delivery times (no more than 3 weeks)
- Can be used in Zone 1 without acceptance or certification
- Prefabricated and ready for use with entries, bus rails, connection terminals, etc.
- Modifications, add-ons and customer-specific adaptations possible

WebCode **8150D**



With the IS1+ standard enclosures for Zone 1, we offer you a variety of prefabricated field enclosures made from stainless steel 1.4301 (V2A). They include all entries, bus rails, cable ducts, CPM sockets and connection terminals for auxiliary power.

Once the IS1+ components (available separately) have been installed, the enclosures can be used in Zone 1 without acceptance, and they fulfil the requirements of EN 61439.

	ATEX / IECEx					
Zone	0	1	2	20	21	22
Installation in		•	•			

Selection Table						
Product Description	IS1 RIO station With shield bus With cable duct And power terminals					
Installation	Zone 1					
Dimensions (WxHxD)	Built-in unit 1	Product Type	Art. No.	PS	Weight kg	
360 x 750 x 230 mm	1 x BusRail for 6 slots (1 x CPM, 5 x I/O – modules)	IS1 RIO Station360x750x230_6 Slot_Z1	244147 ▲	22	25.000	
360 x 1300 x 230 mm	1 x BusRail for 9 slots (1 x CPM, 8 x I/O – modules)	IS1 RIO Station360x1300x230_10 Slot_Z1	244143 ▲	22	45.000	
600 x 600 x 230 mm	1 x BusRail for 8 slots (1 x CPM, 7 x I/O – modules)	IS1 RIO Station600x600x230_8 Slot_Z1	244142 ▲	22	35.000	
760 x 760 x 300 mm	1 x BusRail for 10 slots (1 x CPM, 8 x I/O – modules)	IS1 RIO Station760x760x300x10 Slot_Z1	244144 ▲	22	55.000	
800 x 1000 x 300 mm	2 x BusRail for 2x8 slots (2 x CPM, 2x7 x I/O – modules)	IS1 RIO Station800x1000x300_2x8 Slot_Z1	244146 ▲	22	70.000	

Technical Data	
Explosion Protection	
IECEx gas explosion protection	Ex db eb ib [Ia Ga] IIC T4 Gb
ATEX gas explosion protection	Ⓔ II 2 G Ex db eb ib [Ia Ga] IIC T4 Gb
EAC gas explosion protection	Ⓕ 1 Ex e* IIC ... IIA T6 ... T3 Gb X
Electrical Data	
Rated operational voltage DC	24 V
Ambient Conditions	
Ambient temperature	-20 °C ... +50 °C
Mechanical Data	
Degree of protection (IP)	IP65

Technical Data

Mechanical Data	
Enclosure material	1.4301 stainless steel

Dimensional Drawings (All Dimensions in mm [inches]) – Subject to Alterations

A4

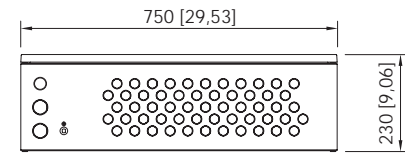
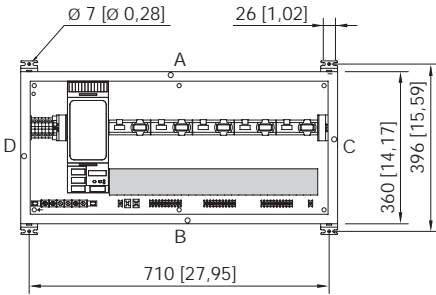

1 x BusRail for 6 slots
Art. No. 244147

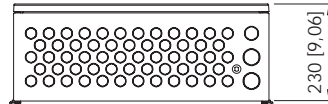
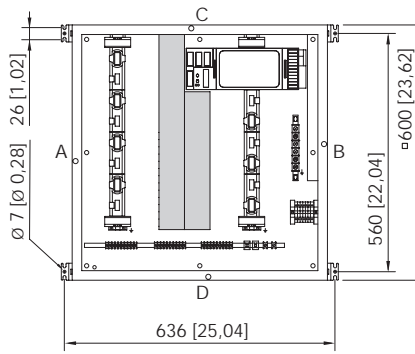

1 x BusRail for 8 slots
Art. No. 244142

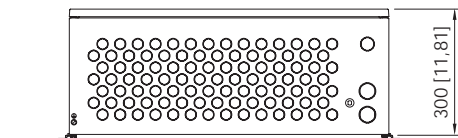
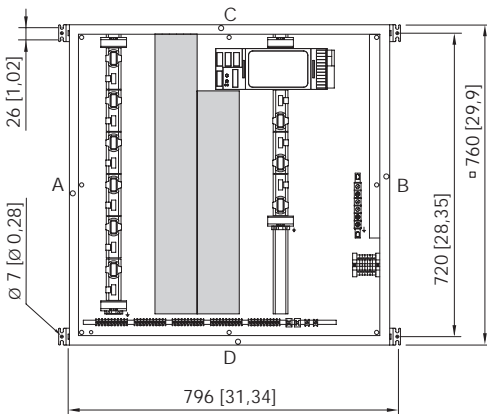

1 x BusRail for 10 slots
Art. No. 244144

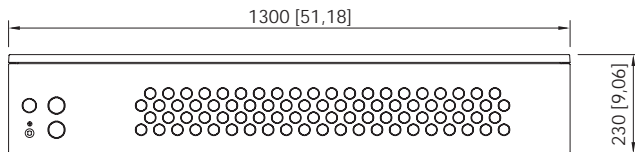
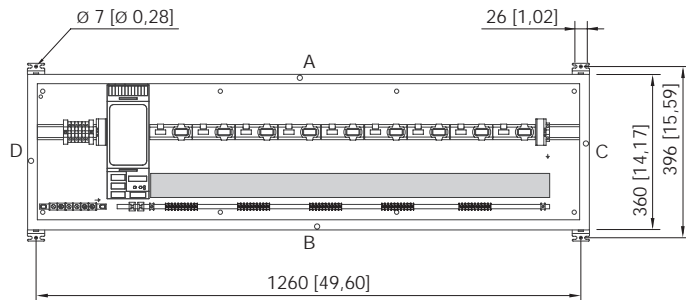

1 x BusRail for 9 slots
Art. No. 244143

A4

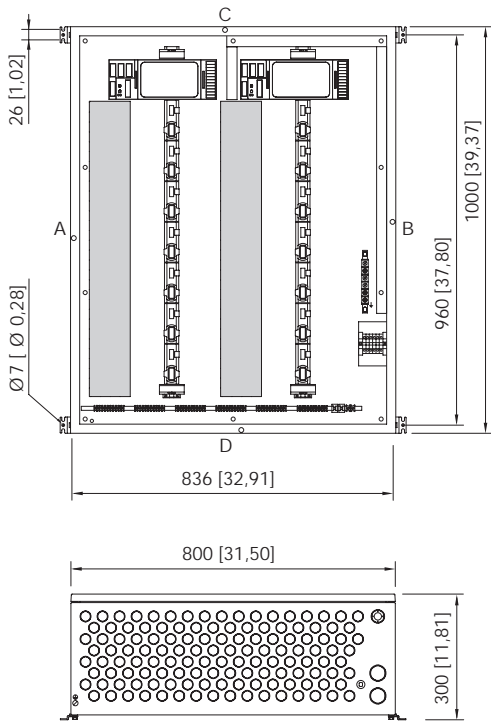

2 x BusRail for 2x8 slots
Art. No. 244146

